



Luxury Homes
ARCHITECTURE & INTERIORS

SOFAS

SILLONES I ARMCHAIRS

POUFFS

MESAS I TABLES

SILLAS I CHAIRS

COMEDORES I DINING TABLES

MUEBLES I FURNITURE

DORMITORIOS I BEDROOMS

ESPEJOS I MIRRORS

ALMOHADILLAS I PILLOWS

EXTERIOR I OUTDOOR

ALMOHADILLAS I PILLOWS



1609 SOFA
PAG. 8



1699 SOFA
PAG. 12



1714 SOFA
PAG. 16



1716 SOFA
PAG. 20



1725 SOFA
PAG.25



1726 SOFA
PAG. 30



1728 SOFA
PAG. 38



1729 SOFA
PAG. 42



1731 SOFA
PAG.46



1735 SOFA
PAG. 50



1739 SOFA
PAG. 54



1741 SOFA
PAG. 58



1742 SOFA
PAG.62



1745 SOFA
PAG. 70



1746 SOFA
PAG. 80



1750 V1 SOFA
PAG. 86



1750 V2 SOFA
PAG. 90



1752 SOFA
PAG.94

1609

1609 CHESTER
 4227/1 MESA | TABLE
 4221/4 MESA | TABLE



Sofá chester 1609 tapizado en ecopiel Acua Negro 90 (S.2) y patas de haya barnizadas en color nogal (F1).
Mesa 4227/1 con estructura de haya lacada en cobre brillo (F7). El tablero de la mesa es de cristal tintado en color bronce. En la parte derecha, **mesa de rincón 4221/4** con patas de madera de haya lacada en cobre brillo y la tablero barnizado en nogal brillo (F7).

Sofa chester mod. 1609 upholstered in ecoleather Acua Negro 90 (S.2) and beech wood legs Varnished in walnut (F1). **Table mod. 4227/1** laquered in glossy copper (F7) with glass tinted bronze top. On the right, **table mod.4221/4** with base laquered in glossy copper and top in gloss walnut (F7).

1609

1609 CHESTER

Detalle sofá chester 1609 tapizado en piel Antiq Colonial Cognac (S.11).

Chester mod. 1609 detail upholstered in leather Antiq Colonial Cognac (S.11).



1609

SILLÓN
ARMCHAIR

SOFA 184 CM

SOFA 220 CM

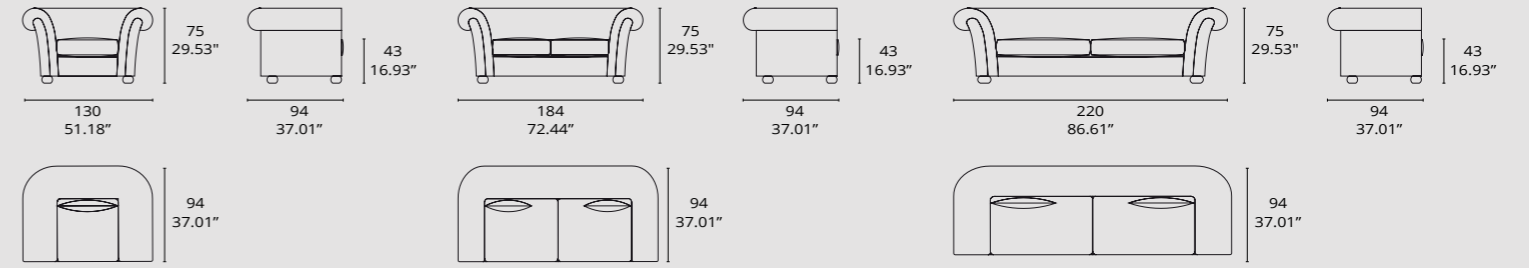

1699

1699 SOFÁ | SOFA
 1749 SILLÓN | ARMCHAIR
 1734 POUFF
 4230/1 V1 MESA | TABLE
 4227/32 MESA | TABLE



Sofá 1699 (izqda.) tapizado en tela Maxxi C/34 (S.2) y (drcha.) en combinación de tela Maxxi C/10 (S.2) y piel Vinci C/Arena (S.10). En ambos sofás, patas de madera de haya barnizadas en color roble oscuro (F1). **Sillón 1749** giratorio tapizado en tela Beaux Z474/03 Affogato (S.9) con base de madera lacada en antracita brillo (F7). **Pouff 1734** en piel Ascot Cobalto (S.17) con patas lacadas en marrón brillo (F6).

Sofa mod.1699 (left) in fabric Maxxi C/34 (S.2), (right) in fabric and leather, Maxxi C/10 (S.2) and Vinci C/Arena (S.10). The legs are varnished in dark oak (F1). **Swivel armchair mod.1749** upholstered in fabric Beaux Z474/03 Affogato (S.9). The base is lacquered in glossy antracithe (F7). **Pouff mod.1734** upholstered in leather Ascot Cobalto (S.17). Legs are lacquered in glossy brown (F6).

1699

1699 SOFÁ | SOFA

(Abajo) **Sofá 1699** tapizado en tela Maxxi C/34 (S.2). (Right) Detalle de tapizado combinando tela y piel. Asiento y respaldo tapizado en Maxxi C/10 (S.2) y parte trasera del respaldo en piel Vinci C/Arena (S.10). Patas de haya barnizadas en roble oscuro (F1).

(Down) **Sofa mod.1699** in fabric Maxxi C/34 (S.2). Upholstered details in fabric and leather. Back and seat are upholstered in Maxxi C/10. The back part upholstered in Vinci C/Arena. Legs are varnished in dark oak (F1).



1699

SOFA

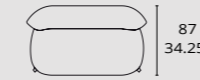

SILLÓN
ARMCHAIR

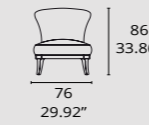

CHAISE LONGUE

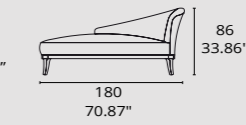
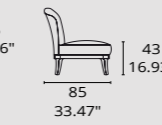
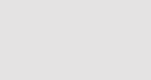
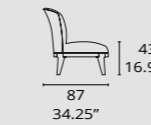
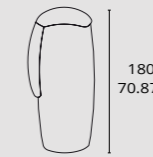
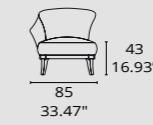

1714



1714 SOFÁ | SOFA
4233/7 APARADOR BAJO | LIVING SIDEBOARD
4227/1 MESA | TABLE
4227/32 MESA | TABLE
1751 SILLÓN | ARMCHAIR
4226 V1 MESA | TABLE
4226 V2 MESA | TABLE
4230 MESA | TABLE

Sofá 1714 tapizado en tela Pastel Poetry CH2890/073 (S.3). Los elementos decorativos del cinturón, reposacabezas y patas se realizan con piel Vinci Toffee (S.10). Almohadillas 70x70 en tela Niara C/21 (S.E) y almohadilla 50x50, con bordado, en tela Muscari 1-6891-060 (S.3). **Sillón 1751** tapizado en tela Lennox 1-6847-190 (S.2) y patas barnizadas en color wengue (F1).

Sofa mod.1714 upholstered in fabric Pastel Poetry CH2890/073 (S.3). Belts and legs details are in leather Vinci Toffee (S.10). Pillows 70x70 in fabric Niara C/21 (S.E) and pillows 50x50 in fabric Muscari 1-6891-060 (S.3). **Armchair mod.1751** upholstered in fabric Lennox 1-6847-190 (S.2), legs are varnished in wenge (F1).

1714

1714 SOFÁ | SOFA



Detalles **sofá 1714** tapizado en tela Pastel Poetry CH2890/073 (S.3) con elementos decorativos en piel Vinci Toffee (S.10). Almohadillas 70x70 en la tela Niara C/21 (S.E). Foto arriba derecha. Sofá tapizado con combinación de tres telas: Base en tela Texas C/5 (S.2), asientos en Kazar C/07 (S.2) y respaldos en Global Friend CH2844-070 (S.3). Elementos decorativos en Piel Antiq Colonial Testa Di Moro (S.11).

Sofa mod.1714 details upholstered in fabric Pastel Poetry CH2890/073 (S.3) and details in leather Vinci Toffee (S.10). Pillows 70x70 in fabric Niara C/21 (S.E). Photo up right. Sofa upholstered with a combination of three fabrics: Base in fabric Texas C/5 (S.2), seats in fabric Kazar C/07 (S.2) and back cushions in fabric Global Friend CH2844-070 (S.3). Leather details in Antiq Colonial Testa Di Moro (S.11).

1714 SOFÁ | SOFA

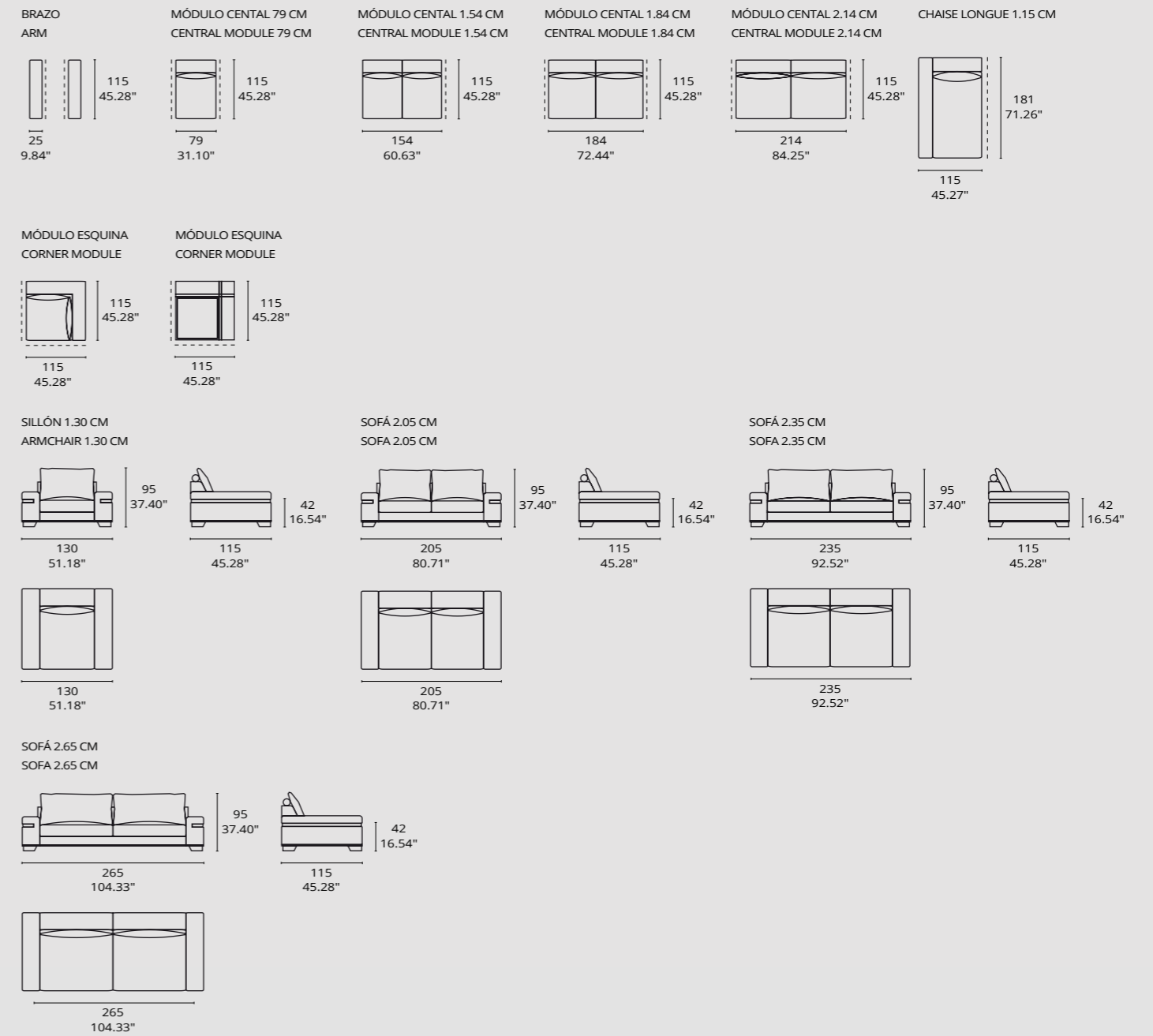

1716



1716 SOFÁ | SOFA
 1290 SILLÓN | ARMCHAIR
 1290 POUFF
 4208/1 MESA | TABLE
 4227/32 MESA | TABLE
 4233/9 CONSOLA | CONSOLE

Sofá 1716 tapizados en tela Perino Velvet CA 1494/073 (S.4) y almohadones de respaldo en tela Montebruno CA 1463/020 (S.4). Ver referencia de almohadillas decorativas en capítulo "Almohadillas" de este catálogo. **Sillón 1290** con estructura de madera de roble barnizado en oscuro y tapizado en piel Ascot C/Arena (S.17). **Pouff 1290** realizado en la misma combinación que el sillón. El pouff dispone de ruedas.

Sofa mod. 1716 upholstered in fabric Perino Velvet CA 1494/073 (S.4) and back pillow in Montebruno CA 1463/020 (S.4). **Armchair mod.1290** with oak frame varnished in dark (F1) and upholstered in leather Ascot C/Arena (S.17). For more information about "Pillows". **Pouff mod. 1290** are in the same leather as the armchair. The pouff has wheels.

1716

1716 SOFÁ | SOFA
 4208/1 MESA | TABLE
 4208/3 MESA | TABLE
 4227/32 MESA | TABLE



Sofá 1716 tapizados en tela Perino Velvet CA 1494/073 (S.4) y almohadones de respaldo en tela Montebruno CA 1463/020 (S.4). Ver referencia almohadilla decorativas en capítulo "Almohadillas" de este catálogo. **Mesas 4208** con estructura de madera de Iroko natural (F1). Los sobre de las mesas son de mármol blanco macael y negro marquina. **Mesa 4227/32** con estructura de madera de iroko natural (F1) y tapa de mármol marrón imperial.

Sofa mod. 1716 in fabric Perino Velvet CA 1494/073 (S.4) and back cushion in Montebruno CA 1463/020 (S.4). For more information, see the chapter "Pillows" in this catalogue. **Tables mod.4208** with frame in natural iroko (F1). Black marquina and white macael marble top. **Table mod.4227/32** in natural iroko (F1) and brown imperial marble top.

1716

1716 SOFÁ | SOFA
4227/32 MESA | TABLE



Detalles del **sofá 1716** en tela Perino Velvet CA 1494/073 (S.4) y almohadones de respaldo en tela Montebruno CA 1463/020 (S.4). **Mesa 4227/32** con estructura de madera de roble con acabado en roble oscuro (F1). La tapa de la mesa es de mármol marrón imperial.

Sofa mod.1716. Base and seat cushion are upholstered in fabric Perino Velvet CA 1494/073 (S.4). Back are upholstered in Montebruno CA 1463/020 (S.4). **Table mod.4227/32** in oak and finished in dark oak (F.1). Brown imperial marble top.

1716 SOFA

MODULO 123 CM



MODULO 135 CM



MODULO 165 CM



SOFA 246 CM

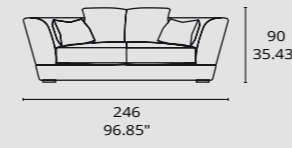

SOFA 270 CM

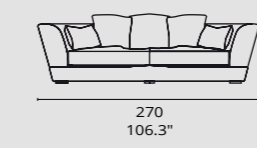

SOFA 330 CM

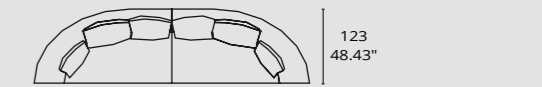
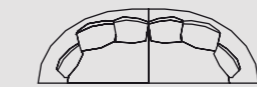
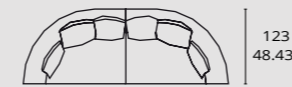
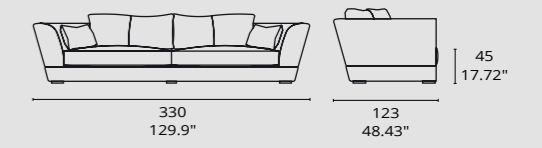

1725



1725 SOFÁ | SOFA
1725 POUFF
1734 SILLÓN | ARMCHAIR
1734 POUFF
4208/1 MESA | TABLE
4208/3 MESA | TABLE
4162 MESA | TABLE

Sofá 1725. Asientos tapizados en tela Random C/01 (S.2) y almohadones de respaldo en tela Frozen Harmony CH 2929/021 (S.3). **Sillón 1734** tapizado en tela Axum C/29 (S.6) y patas lacadas en marrón brillo (F5). **Pouff 1734** en piel Ascot Cobalto (S.17) y patas de madera lacadas en marrón brillo (F5). **Pouff 1725** (izqu.) con zócalo tapizado en ecopiel Premium 604 (S.3) y asiento en tela Mixology 3489-0408 (S.3). Derecha: Pouff con zócalo en tela Random C/01 (S.2) y asiento en tela Frozen Harmony CH2929/021 (S.3).

Sofa mod.1725. Base upholstered in fabric Random C/01 (S.2) and back cushions in fabric Frozen Harmony CH 2929/021 (S.3). **Armchair mod.1734** in fabric Axum C/29 (S.6) with legs lacquered in glossy brown (F5). **Pouff mod.1734** upholstered in leather Ascot Cobalto (S.17) with legs lacquered in glossy brown (F5). **Pouff mod.1725** (left) is upholstered in simil leather Premium 604 (S.3) and seat upholstered in Mixology 3489-0408 (S.3). **Pouff mod.1725** (right) is upholstered in Random C/01 (S.2) and seat upholstered in Frozen Harmony CH2929/021 (S.3).

1725

1725 SOFÁ | SOFA

Detalles del **sofá 1725** con asientos tapizados en tela Random C/01 (S.2). Almohadones de respaldo en Frozen Harmony CH 2929/021 (S.3). Ver información de almohadillas en el capítulo "Almohadillas" de este catálogo. **Mesas 4208** con estructura de madera de Iroko con acabado natural (F1). Las tapas de las mesas son de mármol blanco macael y mármol negro marquina.

Sofa mod. 1725 details with base in fabric Random C/01 (S.2). The back cushions are upholstered in fabric Frozen Harmony CH 2929/021 (S.3). For more information about the pillows, see the chapter "Pillows" in this catalogue. **Tables mod.4208** with base and legs in natural iroko (F1). Black marquina marble top and white macael marble top.



1725

SILLÓN
ARMCHAIR

SOFA 236 CM

SOFA 329 CM

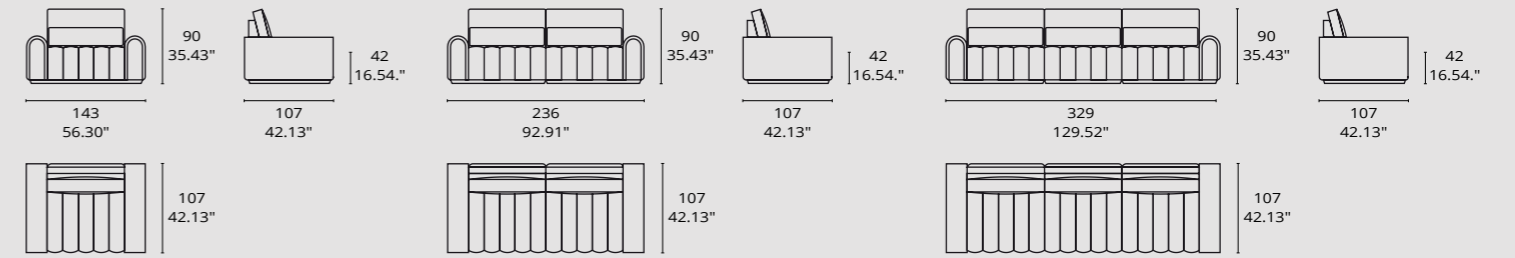

1726

1726 SOFÁ | SOFA
 1743 SILLÓN | ARMCHAIR
 4215/1 MESA | TABLE
 4215/2 MESA | TABLE
 4215/7 MESA | TABLE



Sofá modular 1726 tapizado con tela Random C/11 (S.2) en la base y con tela Globalist TH 2841/095 (S.3) en los almohadones de respaldo y de asiento. Ver almohadillas en capítulo "Almohadillas" de este catálogo. **Sillón 1743** tapizado con la combinación de tela Mara 42 SR-3-72842/14 (S.2) y piel Firenze Pietra (S.11). La tela de la almohadilla es Buckingham C/6 (S.8). Patas del sillón lacadas en antracita brillo (F7). **Mesas 4215** tapizadas con la tela Fuse CA 1199/022 (S.3) en el exterior y tela Mixology 3489 1836 (S.3) en el interior. Cercos de madera de haya barnizado en wengue (F1).

Sofa mod.1726 is upholstered in fabric Random C/11 (S.2). Back and seats cushion in fabric Globalist TH 2841/095 (S.3). **Armchair mod.1743** upholstered in fabric Mara 42 SR-3-72842/14 (S.2) and leather Firenze pietra (S.11). The pillow is in fabric Buckingham C/6 (S.8). The legs of armchairs are lacquered in glossy anthracite (F7). **Tables mod.4215** upholstered in Fuse CA 1199/022 (S.3) and Mixology 3489 1836 (S.3). The frame are varnished in wengue (F1).

1726

1726 SOFÁ | SOFA
4215/7 MESA | TABLE



Sofá modular 1726 con base tapizada en piel Firenze Gris (S.11) y almohadones de asiento y de respaldo en tela Globalist CH 2841/091 (S.3). **Mesa 4215/7** tapizada en tela Fuse CA 1199/022 (S.3) para el exterior y Mixology 3489 1836 (S.3) en el interior. Cerco de madera de haya barnizado en wengue (F1).

Modular sofa 1726 is upholstered in fabric and leather. The base of the sofa is upholstered in leather Firenze Gris (S.11) and seat and back cushions are upholstered in Globalist CH 2841/091 fabric (S.3). **Tables mod.4215/7** upholstered in Fuse CA 1199/022 (S.3) and Mixology 34891836 (S.3). The frame are varnished in wengue (F1).

1726

- 1726 SOFÁ | SOFA
- 4215/1 MESA | TABLE
- 4215/7 MESA | TABLE
- 1729 SILLÓN | ARMCHAIR

En la página derecha. **Sofá modular 1726** tapizado con la base en piel Firenze Pietra (S.11) y almohadones de asiento y respaldo Globalist CH 2841/071 (S.3). Almohadillas decorativas en las telas Zenith 9019/03 Jasper (S.E) (diseño zig-zag), Quanta 9026/03 French Blue (S.E) y Katy C/519 (S.9) con bordado.

Mesas 4215 tapizadas en tela Fuse CA 1199/022 (S.3) para el exterior y Mixology 3489 1836 en el interior. Cerco de madera de haya barnizado en wengue (F1).

Sillón 1729 tapizado en tela Katy C/519 Azul (S.9). Estructura de madera de roble acabado lacado en negro (F1).

On the right page. **Modular sofa 1726** upholstered in fabric and leather, base in leather Firenze C/ Pietra (S.11) and the back and seat cushions are upholstered in fabric Globalist CH 2841/071 (S.3). The pillows are in fabric Zenith 9019/03 Jasper (S.E) (zig-zag design), Quanta 9026/03 French Blue (S.E) y Katy C/519 (S.9) with embroidery.

Tables mod.4215 upholstered in Fuse CA 1199/022 (S.3) and Mixology 3489 1836 (S.3). The frame are varnished in wengue (F1).

Armchair mod. 1729 is upholstered in fabric Katy C/519 (S.9) wiht oak wood structure in wengue finish (F1).

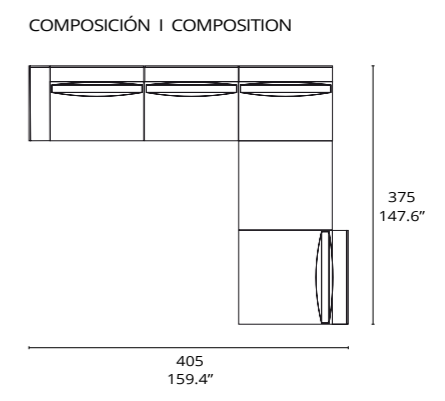

1726

1726 SOFÁ | SOFA



Detalle del tapizado de **sofá modular 1726** en tela Random C/11 (S.2) con almohadones de respaldo y de asiento tapizados en tela Globalist TH 2841/095 (S.3). Almohadilla Montecristo 3949 04 89 (S.8). En la página siguiente: **Sofá 1726** con base tapizada en tela Random C/11 y almohadones de asiento y respaldo en tela Maxxi C/27 (S.2). Almohadillas decorativas en Saint Honore 1-8774-050 (S.E) y Avant la Lettre CA 1365-080 (S.9).

Sofa details **mod.1726** is upholstered in fabric. The base of the sofa is upholstered in fabric Random C/11 (S.2). Back and seats cushion are upholstered in fabric Globalist TH 2841/095 (S.3). Pillow in fabric Montecristo 3949 04 89(S.8) The next page. **Sofa 1726**. The base of sofa is upholstered in embroidered fabric Random C/11 (S.2). Back and seat cushion are upholstered in fabric Maxxi C/27 (S.2). Pillows in fabric Saint Honore 1-8774-050 (S.E) y Avant la Lettre CA 1365-080 (S.9).

1726 SOFÁ | SOFA

BRAZO | ARMREST

BRAZO SOFA SOFA ARMREST

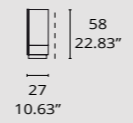

BRAZO CHAISE LONGUE CHAISE LONGUE ARMREST

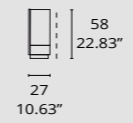

MÓDULOS CENTRALES | CENTRAL MODULE

MÓDULO CENTRAL 92 CM CENTRAL ELEMENT 92 CM

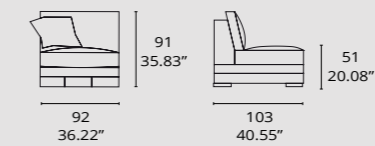

MÓDULO CENTRAL 126 CM CENTRAL ELEMENT 126 CM

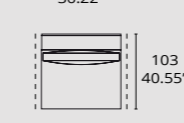
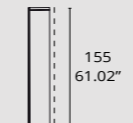
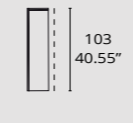
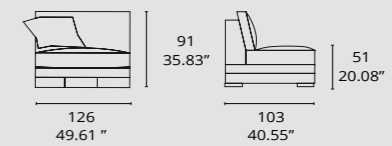

CHAISE LONGUE

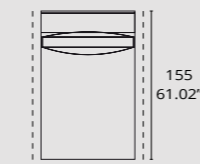
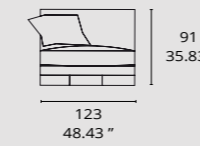

POUFF

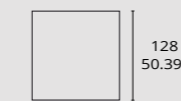
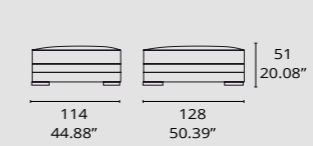

SOFA 146 CM

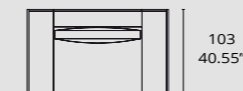
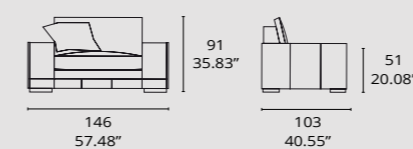

SOFA 238 CM

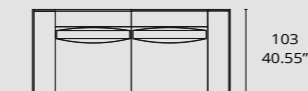

SOFA 330 CM

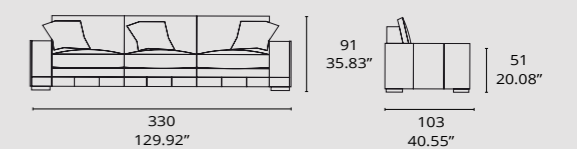

1728

1728 SOFÁ | SOFA

1728 SILLÓN | ARMCHAIR

1290 POUFF

4162 MESA | TABLE

4220/1 MESA | TABLE

4233/7 APARADOR BAJO | LIVING SIDEBOARD

Sofá 1728 en tela Savoy C/28 (S.2) y **Sillón 1728** en piel Firenze C/Pepper (S.11). **Pouff 1290** tapizado en piel Ascot C/814 Arena (S.17) y cerco de madera de haya está barnizado en roble oscuro (F1).

Mesa 4220/1 fabricada en madera de roble acabada en roble natura y oro (F2) con tablero tapizado en piel Firenze Pepper (S.11). **Aparador bajo 4233/7** con estructura de madera de roble chapada y barnizado en roble natura combinado con lacado mostaza alto brillo en cajones y trasera (F6).

Sofa mod.1728 upholstered in fabric Savoy C/28 (S.2). **Armchair mod.1728** upholstered in leather Firenze C/Pepper (S.11). **Pouff 1290** is upholstered in leather Ascot C/814 Arena (S.17) and the wooden frame is varnished in dark oak (F1). **Table 4220/1** is in natural oak and gold (F2) and top upholstered in leather Firenze Pepper (S.11). **Living sideboard mod.4233/7** with oak frame and varnished in natural oak, with drawers and back part lacquered in glossy mustard (F6).



1728

1728 SOFÁ | SOFA
1728 SILLÓN | ARMCHAIR

1728

SOFA

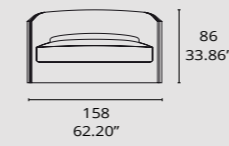

SILLÓN | ARMCHAIR



SILLA | CHAIR

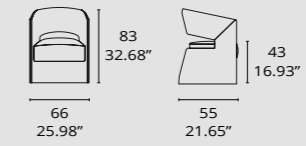

Sofá 1728 tapizado en la tela Savoy C/28 (S.2). Foto de la derecha. Detalle de sillón 1728 tapizado en la piel Firenze C/Pepper (S.11).

Sofa mod.1728 upholstered in fabric Savoy C/28 (S.2). Photo on the right. Armchair mod.1728 details, upholstered in leather Firenze C/Pepper (S.11).



1729

1729 SOFÀ | SOFA
 4232/1 MESA | TABLE
 4232/3 MESA | TABLE
 1749 SILLÓN | ARMCHAIR
 4215/15 VITRINA | CUPBOARD



Sofá 1729 tapizado en piel Dalmata C/28 (S.11) y estructura en madera de roble barnizada en color wengue (F1). **Sillón 1749 giratorio** tapizado en tela Beaux Z474/01 Calico (S.9) con base lacada en cobre brillo (F7). **Mesa 4232/1** tapizada en ecopiel Acua C/Arena 07 (S.2). **Mesas 4232/3** (izq.) tapizada en ecopiel Acua C/Mushroom 84 (S.2). **Mesa 4232/3** (dcha.) está tapizada en la piel Interludio C/60 (S.11). Todas estas mesas tienen el sobre de madera con acabado en nogal natural (F1). **Vitrina 4215/15** tapizadas con la tela Fuse CA 1199/022 (S.3) con cercos y patas de madera de haya lacado en marrón brillo y detalles en oro (F6).

Sofa mod. 729 upholstered in leather Dalmata C/28 (S.11) with legs varnished in wenge (F1). **Swivel armchair mod.1749** upholstered with Beaux Z474/01 Calico (S.9). The swivel base is laquered in glossy copper (F7). **Table mod.4232/1** upholstered in Acua C/Arena 07 (S.2). **Table mod.4232/3** (left) is upholstered with Acua C/Mushroom 84 (S.2). **Table mod.4232/3** (right) upholstered in leather Interludio C/60 (S.11). All the tables have a natural walnut top (F1). **Cupboard mod.4215/15** upholstered in Fuse CA 1199/022 (S.3) with frame lacquered in glossy brown with gold details (F6).

1729

1729 SOFÁ | SOFA

Detalle del **sofá 1729** tapizado en piel Dalmata C/28 (S.11). Estructura del sofá en madera de roble acabado wengue (F1).

Sofa mod.1729 detail upholstered in leather Dalmata C/28 (S.11). The frame are made in oak and varnished in wenge (F1).



1729

SOFA

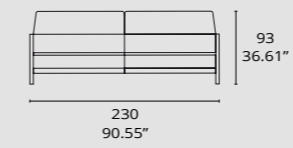

SILLÓN | ARMCHAIR

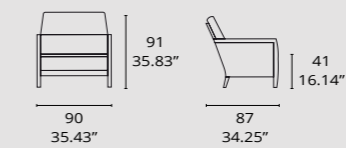

1731

1731 SOFÁ | SOFA
 1292 SILLÓN | ARMCHAIR
 1748 POUFF
 4231/1 MESA | TABLE
 4231/14 APARADOR | SIDEBORD



Sofá 1731 tapizado en tela Castelli CA 1418/072 (S.4) con almohadillas de 70x70 en tela Healey F0936/05 Spice (S.7), y almohadilla de 60x60 en Leyburn F0938/06 (S.2). **Sillón 1292** con la parte trasera del respaldo en la tela Crafty CH2935/060 (S.3) y el resto en Pastel Poetry CH2890/063 (S3). Toda la estructura del sillón es de madera de iroko con acabado natural (F1). **Pouff 1748** tapizado en capitoné en piel Firenze Pietra (S.11).

Sofa mod.1731 upholstered in fabric Castelli CA 1418/072 (S.4). The pillows 70x70 are upholstered in fabric Healey F0936/05 Spice 60x60 (S.7), and pillow 60x60 Leyburn F0938/06 (S.2). **Armchair mod. 1292** with back base upholstered in fabric Crafty CH2935/060 (S.3) and back and seat cushions in fabric Pastel Poetry CH-2890/063 (S.3). All the frame is in iroko wood with natural finish (F1). **Pouff mod.1748** upholstered in Firenze Pietra (S.11).

1731

1731 SOFÁ | SOFA



Sofá 1731 tapizado en tela Castelli CA 1418/072 (S.4). Detalles en piel Vinci C/Toffe (S.10). Las almohadillas de 70x70 con la tela Healey F0936/05 Spice 60x60 (S.7) y almohadilla de 60x60 en Leyburn F0938/06 (S.2).

Sofa details mod.1731 upholstered in fabric. The base sofa, seat cushion and back cushion are upholstered in fabric Castelli CA 1418/072 (S.4). Details in leather Vinci C/Toffe (S.10). The pillows of 70x70 in fabric Healey F0936/05 Spice (S.7) and pillows 60x60 Leyburn F0938/06 (S.2).

1731 MODULAR SOFA

MÓDULOS CENTRALES | CENTRAL MODULE

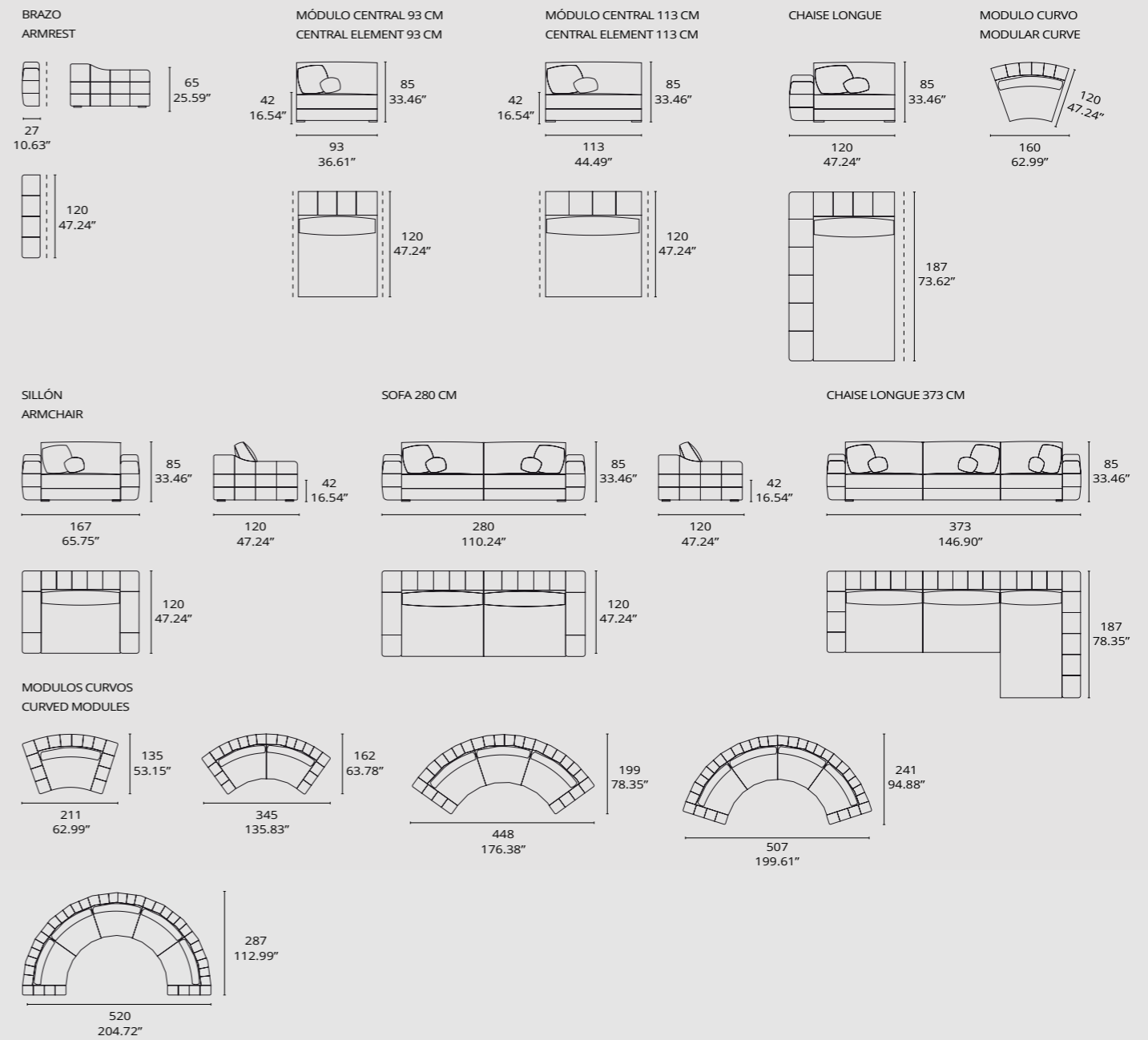

1735



1735 CHESTER
1730 SILLÓN | ARMCHAIR
4207/1 MESA | TABLE
4207/3 MESA | TABLE
4215/14 APARADOR | SIDEBBOARD
1748 POUFF
4230 MESA V.1 | TABLE V.1

Sofá Chester 1735 todo tapizado en la tela Vegas Velvet Plain Dis. 1403 Col.34 (S.6). **Sillón 1730** giratorio tapizado en tela y piel. Toda la base del sillón está hecha con botones y tapizada en la piel Ascot Topo (S.17). El interior del sillón, junto con el almohadón de respaldo y de asiento están tapizados en la tela Avant gardiste CA 1361/080. (S.8) y patas lacadas en marrón brillo (F5). **Pouff 1748** tapizado en capitoné en piel Firenze Pietra (S.11).

Chester sofa mod.1735 upholsterd in fabric Vegas Velvet Plain Dis. 1403 Col.34 (S.6). **Swivel armchair mod.1730** in leather and fabric. All the frame is with buttons and upholstered in Ascot Topo (S.17). The internal part , back and seat cushion are upholstered in fabric Avant Gardiste CA 1361/080 (S.8). The legs are lacquered in glossy brown (F5). **Pouff mod.1748** upholstered in leather Firenze Pietra (S.11).

1735

1735 SOFÁ | SOFA CHESTER
1735 SILLÓN | ARMCHAIR



1735 SOFÁ | SOFA

SILLÓN
ARMCHAIR

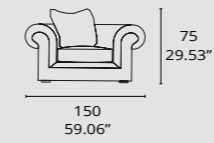

SOFA 205 CM

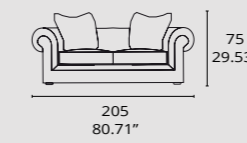

SOFA 250 CM

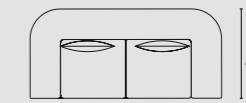
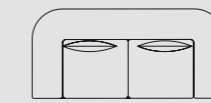
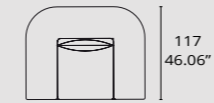
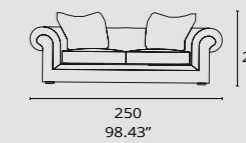

SOFA 300 CM

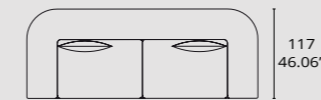
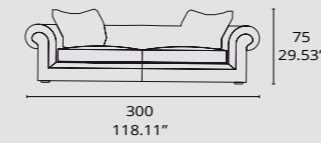

Sillón Chester 1735 combinado en tela y piel con base en piel Savana Moka (S.10). Asiento y almohadillas en la tela Mellite 3507 0202 (S.9).

Sofá Chester 1735 tapizado en la tela Vegas Velvet Plain Dis.1403 Col.34 (S.6). Ver referencia almohadilla decorativas en capítulo "Almohadillas" de este catálogo.

Chester armchair mod.1735 upholstered in fabric and leather. The base of sofa is upholstered in Savana Moka (S.10). The seat cushion and pillows are upholstered in Mellite 3507 0202 (S.9).

Chester sofa mod.1735 upholstered in fabric Vegas Velvet Plain Dis.1403 Col.34 (S.6). For more information, see the chapter "Pillows" in this catalogue.

1739

1739 SOFÁ I SOFA
 1743 BANQUETA I BENCH
 1744 SILLÓN I ARMCHAIR
 4221/2 MESA I TABLE
 4221/3 MESA I TABLE
 4221/4 MESA I TABLE
 4216/16 LIBRERÍA I BOOKCASE



Sofá 1739 en combinación de tela y piel, con base tapizada en piel Firenze Pietra (S.11). El interior del sofá junto con los respaldos y el asiento está tapizados en la tela Sweet Kiss CH 2918/171 (S.5). **Sillón giratorio 1744** con base en piel Nature Col.1125 (S.12), interior en tela Passion C/3 (S.4) y asiento y almohadón de respaldo tapizados en la Intreccio C/3 (S.8). Base giratoria de lacada en bronce brillo (F7).

Sofa mod.1739 in fabric and leather. Base upholstered in Firenze Pietra (S.11). The seat and back cushion upholstered in Sweet Kiss CH 2918/171 (S.5). **Swivel armchair mod.1744** with base in leather Nature col.1125 (S.12) and interior in fabric Passion C/3 (S.4). Seat and back cushions upholstered in fabric Intreccio C/3 (S.8). The swivel base is lacquered in glossy bronze (F7).

1739

1739 SOFÁ I SOFA



En esta página, **Sofá 1739** tapizado en tela y piel con base tapizada en la piel Firenze Pepper (S.11). Asiento y respaldos en la tela Kazar C/09 (S.2). Almohadillas en telas Bowie C/06 (S.4) y Kazar C/17 (S.2).

In this page, **Sofa mod.1739** upholstered in fabric and leather. The base is upholstered in Firenze Pepper (S.11) leather. The seat cushion and back cushion upholstered in fabric Kazar C/09 (S.2). The pillows upholstered in fabrics Bowie C/06 (S.4) and Kazar C/17 (S.2).

1739 SOFA

SILLÓN
ARMCHAIR

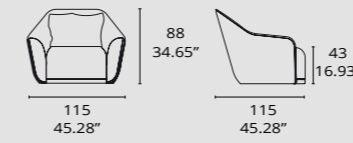

SOFA 205 CM

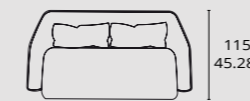
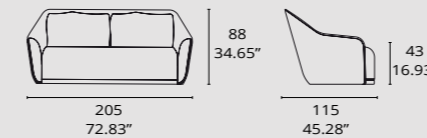

SOFA 255 CM

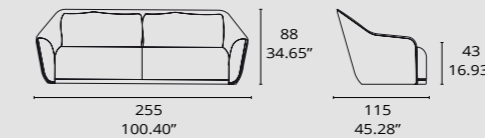

SOFA 305 CM

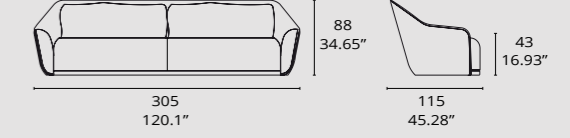

1741

1741 SOFÁ | SOFA
 1741 SILLÓN | ARMCHAIR
 4230/1 V1 MESA | TABLE
 4230/3 V3 MESA | TABLE
 4233/7 APARADOR BAJO | LIVING SIDEBBOARD



Sofá 1741 tapizado en tela Billy Velvet Dis.1656 C/27 (S.2) con patas lacadas en antracita mate (F4). **Sillón 1741** tapizado en tela Bruma C/402 (S.4) con patas lacadas en antracita mate (F4). **Mesa 4230/1 V1** con estructura de acero bañada en latón envejecido y tapa de cristal parsol 5+5 de color bronce. **Mesa 4230/3 V3** con estructura de acero bañada en latón envejecido y tapa de marmol negro marquina. **Aparador Bajo 4233/7** en madera de sicomoro frisé acabado brillo y gris (F5).

Sofa mod.1741 upholstered in fabric Billy Velvet Dis. 1656 C/27 (S.2). Legs are lacquered in matt anthracite (F4). **Armchair mod.1741** upholstered in fabric Bruma C/402 (S.4) and legs lacquered in matt Anthacite (F4). **Table mod.4230/1 V1** with steel structure in old brass colour and glass top 5+5 in bronze colour. **Table mod.4230/3 V3** with steel structure in old brass and top in marble black marquina. **Living sideboard mod.4233/7** in glossy sycamore frisé and grey interior (F5).

1741

1741 SOFÁ | SOFA

Detalles del **sofá 1741** tapizado en la tela Billy Velvet Dis. 1656 C/27 (S.2) y patas lacadas en antracita mate (F4). Ver referencia almohadilla decorativas en capítulo "Almohadillas" de este catálogo.

Sofa details **mod.1741** upholstered in fabric Billy Velvet Dis. 1656 C/27 (S.2) and legs are lacquered in matt anthracite (F4). For more information, see the chapter "Pillows" in this catalogue.



1741 SOFA

SOFA 180 CM

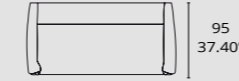
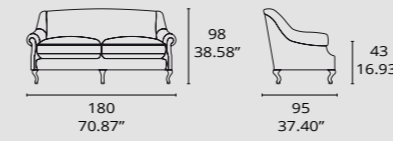

SOFA 230 CM

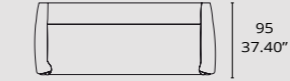
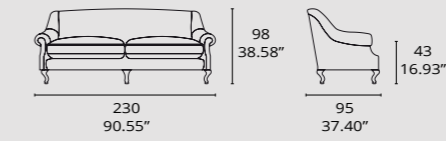

SILLÓN ARMCHAIR

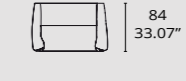
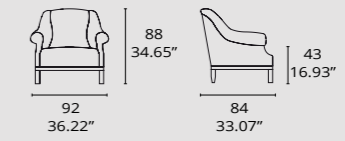

1742



1742 MOD.3 SOFÁ | SOFA
1742 MOD.5 SOFÁ | SOFA
1743 SILLÓN | ARMCHAIR
1748 POUFF
4220/1 MESA | TABLE
4220/7 MUEBLE TV | TV CABINET
4225/16 LIBRERÍA | BOOKCASE
4230/1 V2 MESA | TABLE

Sofá 1742 combinado en tela y piel con base del sofá en piel Ascot Antracita (S.17). Asientos y respaldos tapizados en la tela Ross 1-1335-092 (S.3) y patas del sofá lacadas en antracita brillo (F7). **Sillón 1743** tapizado en tela y piel con base en piel Firenze Pietra (S.11). El interior, respaldo y asiento en tela Mara 42 SR-3-72842/14 (S.2) y patas lacadas en antracita brillo (F7). Tela Buckingham C/6 (S.8) para la almohadilla.

Sofa mod.1742 in fabric and leather. Base upholstered in leather Ascot Antracita (S.17). Back and seat in fabric Ross 1-1335-092 (S.3). The legs lacquered in glossy anthracite (F7). **Armchair mod. 1743** upholstered in fabric and leather with base in leather Firenze pietra (S.11). Interior, back and seat in Mara 42 sr-3-72842/14 (S.2). Legs lacquered in glossy anthracite (F7). Pillow in Buckingham C/6 (S.8).

1742

1742 MOD.5 SOFÁ | SOFA
 1742 MOD.10 SOFÁ | SOFA
 4220/3 MESA | TABLE
 4226 V1 MESA | TABLE



COMPOSICION | COMPOSITION

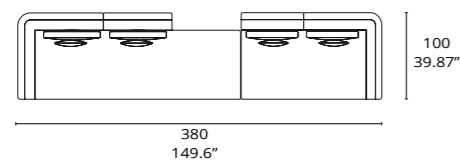

Sofá modular 1742 tapizado en tela y piel. **Módulo 5 (izqu.):** Base tapizada en piel Nature 1125 Grab. TH DIS. 021 (S.17) con almohadones de asiento y respaldo en Maxxi C/05 (S.2). Almohadillas en la tela Dimensions 1-3108-020 (S.9) y patas lacadas en antracita brillo (F7). **Módulo 10 (drcha):** Base tapizada en piel Nature Col.1125 (S.12) y almohadones de asiento y respaldo tapizados en la tela Pompidou C/11 (S.2). Almohadillas en tela Style 1-3107-062 (S.4).

1742 modular sofa upholstered in fabric and leather. Module 5(left): Base upholstered in leather Nature 1125 Grab. TH DIS.021 (S.17). Back and seat cushions in fabric Maxxi C/05 (S.2). Pillows in fabric Dimensions 1-3108-020 (S.9). The legs are lacquered in glossy anthracite (F7). Module 10: Base upholstered in Nature Col.1125 (S.12). Back and seat cushions are in fabric Pompidou C/11 (S.2). Pillows in fabric Style 1-3107-062 (S.4).

1742

1742 SOFÁ | SOFA
 4220/1 MESA | TABLE
 4220/3 MESA | TABLE
 4220/4 MESA | TABLE
 1748 POUFF



COMPOSICION | COMPOSITION

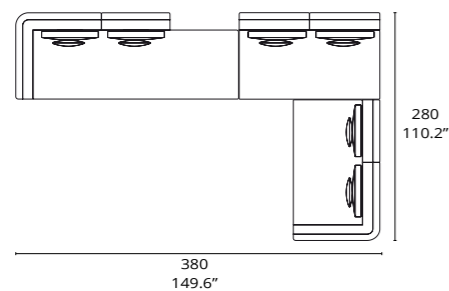

Sofá modular 1742 en combinación de tela y piel. **Módulo 5 (izqu.):** Base tapizada en piel Nature 1125 Grab. TH DIS. 021 (S.17) con almohadones de asiento y respaldo en tela Maxxi C/05 (S.2). Almohadillas en tela Dimensiones 1-3108-020 (S.9). **Módulo 11 (centro) y 10 (drcha.):** Base tapizada en piel Nature Col.1125 (S.12) y almohadones de asiento y respaldo tapizados en la tela Pompidou C/11 (S.2), y patas lacadas en antracita brillo (F7). Almohadillas en las tela Style 1-3107-062 (S.4) y Circular Unico (S.2). **Pouff mod.1748** in fabric Ordesa Blanco (S.2).

1742 modular sofa upholstered in fabric and leather. **Module 5 (left):** Base upholstered in leather Nature 1125 Grab. TH DIS. 021 (S.17). Back and seat cushions are in fabric Maxxi C/05 (S.2). Pillows in fabric Dimensiones 1-3108-020 (S.9). The legs are lacquered in glossy anthracite (F7). **Module 11 (center) and 10 (right):** Base is upholstered in Nature Col.1125 (S.12) and back and seat cushions in fabric Pompidou C/11 (S.2). Pillows in fabrics Style 1-3107-062 (S.4) and Circular Unico (S.2). **Pouff mod.1748** in fabric Ordesa Blanco (S.2).

1742



Detalles sofá modular 1742. Ver almohadillas decorativas en capítulo "Almohadillas" en este catálogo.
 Modular sofa mod.1742 details. For more information about pillows, see "Pillows" chapter in this catalogue.

1742 MODULAR SOFA

BASES | SEATING

MOD. 14

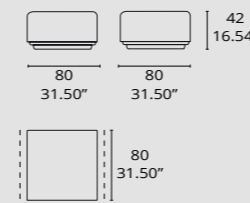

MOD. 12

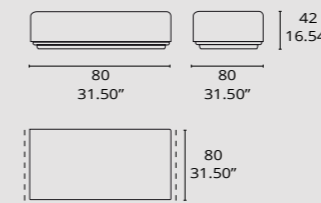

MOD. 8

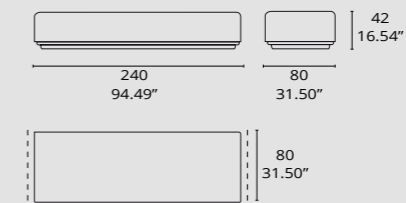

MOD. 13

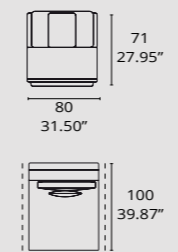

MOD. 11

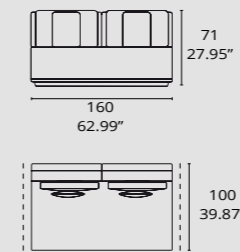

MOD. 7

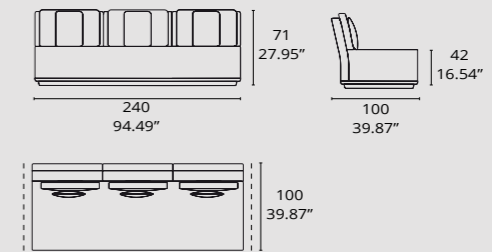

MOD. 9

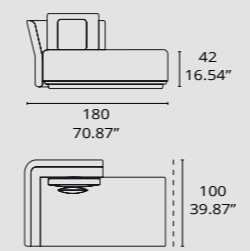

MOD. 4

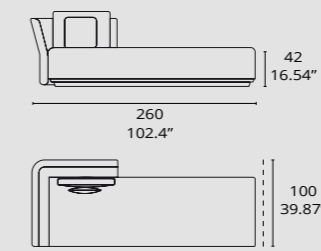

MOD. 5

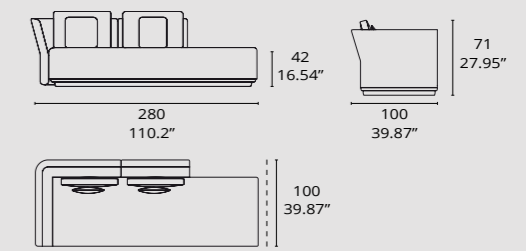

MOD. 10

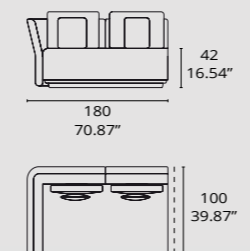

MOD. 6

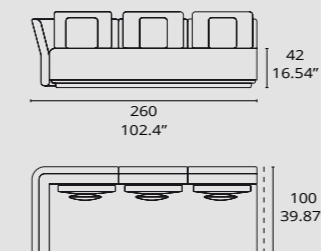

SILLÓN | ARMCHAIR

MOD. 1

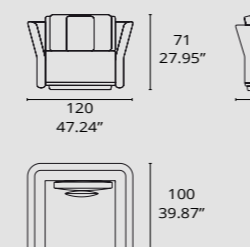

SOFAS

MOD. 2

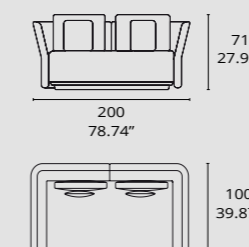

MOD. 3

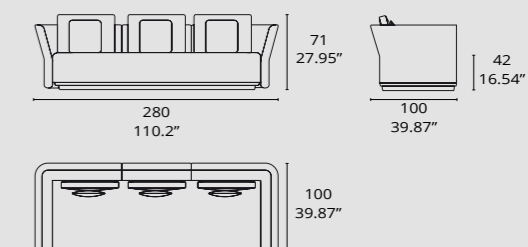

1745

1745 SOFÁ | SOFA
 4220/1 MESA | TABLE
 4220/3 MESA | TABLE
 4220/5 MESA | TABLE

Sofá 1745 modular con base tapizada en tela Denim 1-1352-073 (S.2) y almohadones de asiento y de respaldo en tela Cord Uno CA 1419/071 (S.8). Tela de almohadillas 50x50 Fern LTA 38 (S.4) y 70x70 en Avance CA 1364/020 (S.8). Las placas laterales del sofá y las patas están hechas de madera de roble barnizada natural (F1).

1745 modular sofa is upholstered with fabric. The sofa base is upholstered in Denim 1-1352-073 (S.2). The seat cushion and back cushion are upholstered with Cord Uno CA 1419/071 (S.8). Pillows 50X50 in fabric Fern LTA 38 (S.4) and 70X70 in Avance CA 1364/020 (S.8). The side of the sofa and the legs are made with oak natura (F1)



1745



1745 SOFÁ MODULAR | MODULAR SOFA
4227/32 PEDESTAL TABLE | TABLE
4226/V1 MESA DE RINCÓN | TABLE

Sofá modular 1745 tapizado en tela Pastel Poetry CH2890/050 (S.3). Almohadillas en telas Avant la lettre CA1365/070 (S.9) (geométrico) y Maxxi C/34 (S.2) (azul oscuro). Las placas laterales y las patas están lacadas en antracita brillo (F7). **Mesa 4227/32** con estructura de madera de roble, acabado en roble oscuro (F1). Tapa de mármol marrón imperial.

1745 modular sofa upholstered with fabric Pastel Poetry CH2890/050 (S.3). Pillows in fabric Avant la lettre CA1365/070 (S.9) (geometric design) and Maxxi C/34 (S.2) (dark blue). The side of sofa and the legs are in gloss anthracite (F7). **Table mod.4227/32** in oak and finished in dark oak (F1). Brown imperial marble top.

1745

1745 SOFÁ | SOFA

1290 SILLÓN | ARMCHAIR

1290 POUFF

4227/32 MESAS DE RINCÓN | TABLE Ø 44

4227/32 MESAS DE RINCÓN | TABLE Ø 64



Sofá modular 1745 con base tapizada en tela Denim 1-1352-030 (S.2). Almohadones de asiento y de respaldo en tela Cord. Uno CA 1419/036 (S.8). La tela de las almohadillas son (drcha.) Fern LBI 92 (S.4) y (izqu.) Circular Unico (S.2). Placas laterales y patas en roble nature (F1). **Sillón 1290** en piel Ascot C/Arena (S.17). Estructura de madera de roble barnizada en roble oscuro (F1).

Mod.1745 modular sofa is upholstered in fabric. Base is upholstered in Denim 1-1352-030 (S.2), seat and back cushion are upholstered in Cord Uno CA 1419/036 (S.8). Pillows in fabric (right) Fern LBI 92 (S.4) and (left) Circular Unico (S.2). The side of sofa and legs are made with oak natura (F1). **Armchair mod.1290** upholstered in leather Ascot C/Arena (S.17). The frame is made in oak wood varnished in dark oak (F1).

1745

1745 SILLÓN | ARMCHAIR



Sillón 1745 tapizado en tela y piel. Base y brazos en piel Ascot Pavone (S.17). Almohadones de asiento y de respaldo tapizados en tela Axum C/16 (S.6). Placas laterales y patas del sofá lacadas en antracita brillo (F7). Almohadillas en la tela Fern LTA 38 (S.4)

Armchair mod.1745 upholstered in fabric and leather. Base and arms upholstered in Ascot Pavone (S.17). Back and seat cushions are upholstered in Axum C/16 (S.6). Pillows are in Fern LTA 38 (S.4). The side of sofa and legs are lacquered in glossy anthracite (F7).

1745

1745 SOFÁ | SOFA



Sofá modular 1745 con base en tela Denim 1-1352-033 (S.2). Almohadones de asiento y de respaldo tapizados en la tela Cord Uno CA1419-031 (S.8) y almohadillas en telas Muscari 1-6891-060 (S.3), Contugo C/104 (S.2) y Villa CA1432-070 (S2). Ver referencia de almohadillas en el capítulo de "Almohadillas" en este catálogo. Placas laterales barnizadas en roble oscuro (F1). **Pouff 1749 con giro excentrico** para su uso como pouff o mesa de centro en piel Babel C/Green (S.13) y pata lacada en bronce brillo (F7).

1745 modular sofa curved is upholstered in fabric. The sofa base is upholstered in Denim 1-1352-033 (S.2). The seat cushion and back cushion are upholstered in Cord Uno CA 1419-031 (S.8). Pillows are in fabric Muscari 1-6891-060 with logo (S.3), Contugo C/104 (S.2) and Villa CA1432-070 (S2). For more information, see the "pillows" chapter in this catalogue. The side of sofa and legs are barnished in dark oak (F1) **Pouff 1749 eccentric swivel** for use as a pouff or table, is upholstered in Babel C/Green (S.13) with lacquered frame in glossy copper (F7).

1745

1745 SOFÁ | SOFA



Detalles de las platas laterales del **sofá 1745** en acabados roble natura (F1) y bronce brillo (F7). En la página siguiente. **Sofá modular 1745** con base en tela Denim 1-1352-024 (S.2). Almohadones de asiento y de respaldo tapizados en la tela Cord. Uno CA 1419/093 (S.8) y placas laterales del sofá y las patas están lacadas en bronce brillo (F7).

Details of side of **mod.1745 sofa** are barnished in natural oak (F1) and glossy bronze (F7). The next page, **mod.1745 sofa** modular is upholstared in fabric. The sofa base is upholstered in Denim 1-1352-024 (S.2). The seat cushion and back cushion are upholstered in Cord. Uno CA 1419/093 (S.8). The side of sofa and legs are barnished in glossy bronze (F7).

1745 SOFÁ MODULAR | MODULAR SOFA

SILLÓN
ARMCHAIR

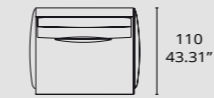
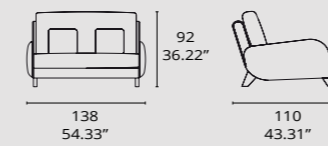

MÓDULO SIN BRAZO
MODULE WITHOUT ARMREST

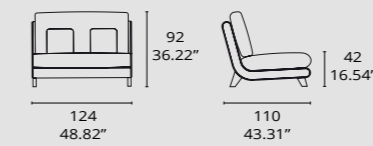

MÓDULO CON BRAZO
MODULE WITH ARMREST

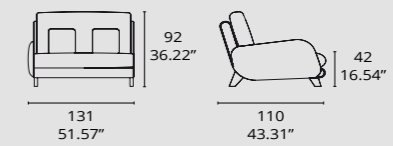

MÓDULO CURVO
CURVE MODULE

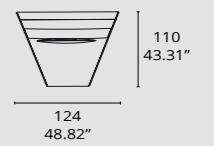

SOFA MODULAR CURVO
MODULAR SOFA CURVED

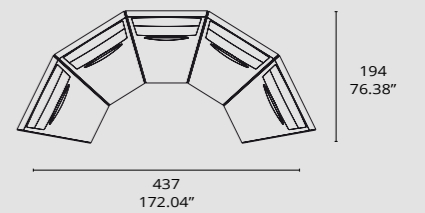
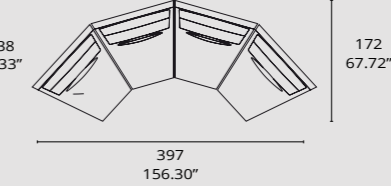
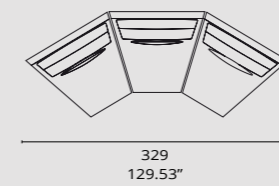
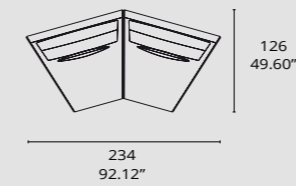

SOFA 248 CM

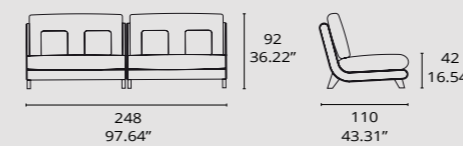

SOFA 372 CM

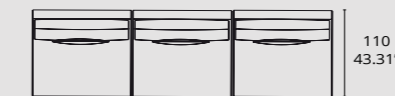
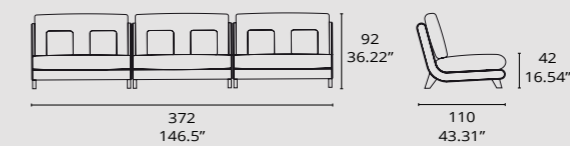

1746

1746 SOFÁ | SOFA
 1290 SILLÓN | ARMCHAIR
 1290 POUFF
 4208/1 MESA | TABLE
 4230/1 V2 MESA | TABLE
 4230/3 V2 MESA | TABLE



Sofá 1746 (izqu.) con base y brazos tapizados en tela Boogie Love CH2930/020 (S.5). Almohadones de asiento y de respaldo tapizados en Frozen CH2928/022 (S.4). **Sofá 1746** (dcha.) con base y brazos tapizados en tela Random c/02 (S.2). Almohadones de asiento y de respaldo tapizados en Novello CA1435/071 (S.5). Ver referencia de almohadillas en capítulo "Almohadillas" en este catálogo. **Sillón 1290** tapizado en piel Ascot C/Arena (S.17) con estructura en madera de roble barnizada en roble oscuro (F1).

1746 sofa (left) is upholstered in fabric. The sofa base and armrest are upholstered in Boogie Love CH2930/020 (S.5). The seat and back cushions are upholstered in Frozen CH2928/022 (S.4). For more information about pillows, see "Pillows" chapter in this catalogue. **1746 sofa** (right). The base and armrest are upholstered in Random c/02 (S.2). The seat and back cushions are upholstered in Novello CA1435/071 (S.5). **Armchair 1290** upholstered in leather Ascot C/Arena (S.17). The legs are varnished in dark oak (F1).

1746

1746 SOFÁ | SOFA
 4220/1 MESA | TABLE
 4220/3 MESA | TABLE
 4226/V1 MESA AUXILIAR | TABLE
 4226/V4 MESA AUXILIAR | TABLE



Sofá 1746 con base y brazos tapizados en la tela Random c/02 (S.2). Almohadones de asiento y de respaldo tapizados en la tela Novello CA1435/071 (S.5). **Mesas 4220/1 y 4220/3** hecha en madera de roble y con acabado natural (F1). La tapa está lacada en oro y tapizada en la piel Firenze Pepper (S.11).

1746 sofa (right). The base and armrest are upholstered in Random c/02 (S.2). The seat and back cushions are upholstered in Novello CA1435/071 (S.5). **Tables mod. 4220/1 y 4220/3** in oak and natural finish (F1). Top with gold detail and upholstered in leather Firenze pepper (S.11).

1746

1746 SOFÁ | SOFA



Sofá 1746 con base y brazos tapizados en la tela Boogie Love CH2930/020 (S.5). Almohadones de asiento y de respaldo tapizados en la tela Frozen CH2928/022 (S.4).

Mod.1746 sofa is upholstered in fabric. The sofa base and armrest are upholstered in Boogie Love CH2930/020 (S.5). The seat and back cushions are upholstered in Frozen CH2928/022 (S.4).



1746 MODULAR SOFA

MÓDULOS
MODULES

MOD.1

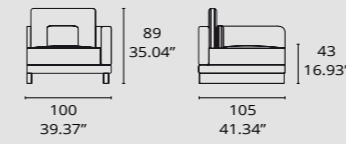

MOD.2

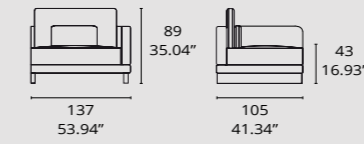

MOD.3

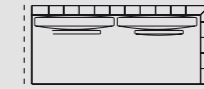
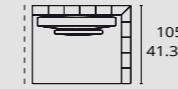
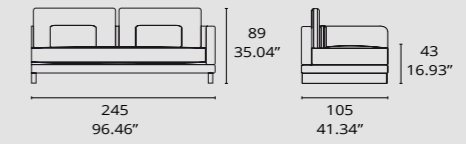

MOD.4

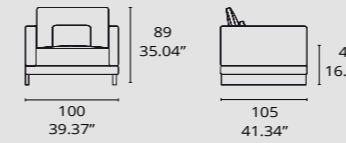

MOD.5

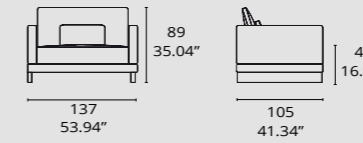

MOD.6

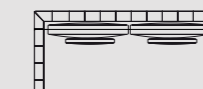
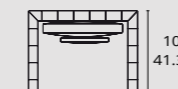
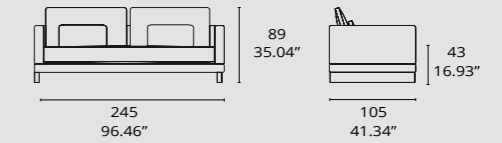



1750_{V1}

1750 SOFÁ | SOFA
1750 SILLÓN | ARMCHAIR
4230/1 V1 MESA | TABLE
4230/1 V2 MESA | TABLE
4233/7 APARADOR BAJO | LIVING SIDEBOARD
4233/15 VITRINA | CUPBOARD

86

87

Sofá 1750 V1 tapizado en la tela Lorenzo 1-3129-033 (S.5) con el respaldo tapizado con pliegues y zócalo lacado en oro patina brillo (F7). **Sillón 1750** tapizado en la tela Lorenzo 1-3129-031 (S.5) con parte trasera tapizada con pliegues y zócalo lacado en oro patina brillo (F7).

Mod.1750 V1 sofa upholstered in fabric Lorenzo 1-3129-033 (S.5). The base is lacquered in glossy gold patina (F7). **Armchairs mod.1750** upholstered in fabric Lorenzo 1-3129-031 (S.5). All the backside part is with folds. The wooden base is lacquered in glossy gold patina (F7).

1750_{v1}

1750 SOFÁ | SOFA
4230/1 V2 MESA | TABLE



Detalles **sofá 1750 V1** tapizado en la tela Lorenzo 1-3129-033 (S.5) con respaldo tapizado con pliegues y zócalo lacado en oro patina brillo (F7). Almohadilla 50x50 en tela Erbusco Spice 9037/03 (S.E) y 70x70 Gastby F1072-04 Ivory (S.4).

Sofa mod.1750 V1 Upholstered in fabric Lorenzo 1-3129-033 (S.5). All the back is with folds. The base is lacquered in glossy gold patina (F7). Pillow 50x50 en tela Erbusco Spice 9037/03 (S.E) y 70x70 Gastby F1072-04 Ivory (S.4).

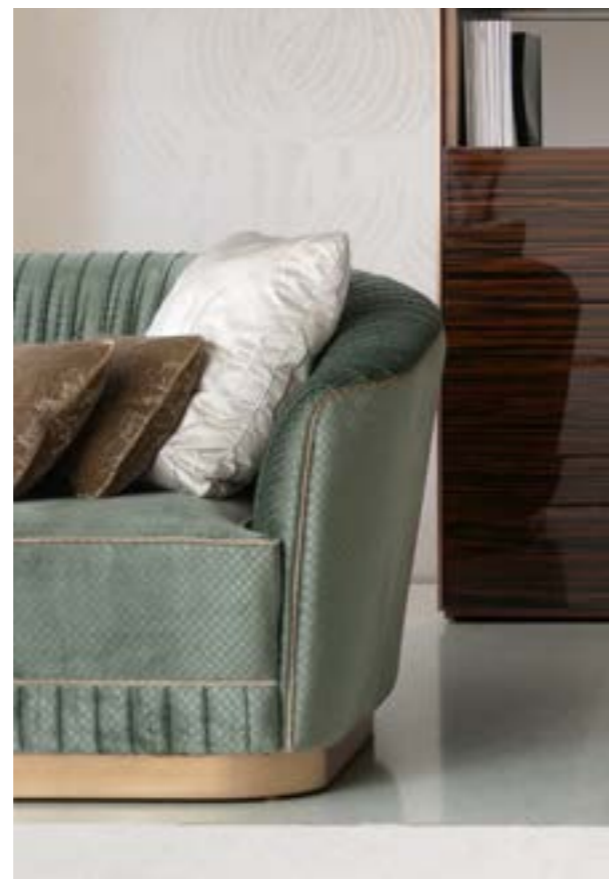

1750 SOFA V1

SOFA 162 CM

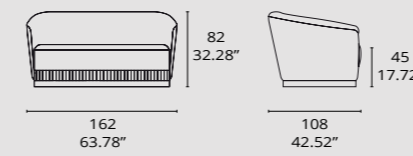

SOFA 202 CM

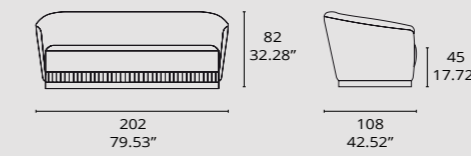

SOFA 242 CM

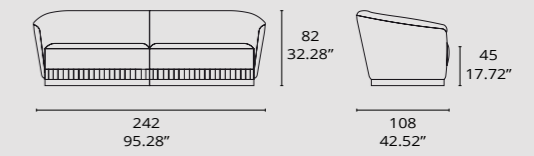

SOFA 282 CM

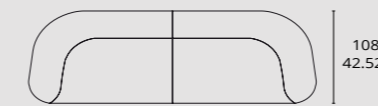
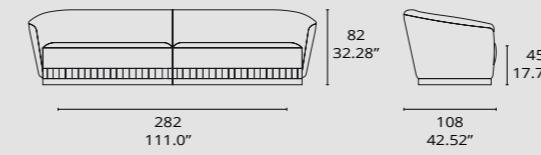

1750 v2

1750 SOFÁ | SOFA

1292 SILLÓN | ARMCHAIR

4232/1 MESA | TABLE

4232/3 MESA | TABLE

4215/15 VITRINA | CUPBOARD



Sofá 1750 tapizado en tela Mirage Dis.1632 Col.02 (S.4) con zócalo lacado en antracita brillo (F7). Sillón 1292 con base en tela Crafty CH2935/060 (S.3), respaldo y almohadón de asiento en tela Pastel Poetry CH2890/063 (S.3). Toda la estructura del sillón es de madera de iroko en acabado natural (F1).

Sofa mod.1750 upholstered in fabric Mirage Dis. 1632 Col.02 (S.4). The base is lacquered in glossy anthracite (F7). Armchair Mod.1292. The base is upholstered in fabric Crafty CH2935/060 (S.3). Back and seat cushions are upholstered in fabric Pastel Poetry CH2890/063 (S.3). All the frame is in iroko wood with natural finish (F1)

1750_{v2}

1750 SOFÁ | SOFA
4232/3 MESA | TABLE

Sofá 1750 en tela Mirage Dis. 1632 Col.02 (S.4) y zócalo lacado en antracita brillo (F7). De derecha a izquierda, Almohadilla 60x60 Goat 002 TJ0655-002-140 (S.6), Frozen CH 2928/076 (S.4) y Kravet 34213 C/16 (S.E).

Sofa mod.1750 upholstered in fabric Mirage Dis. 1632 Col.02 (S.4). The base is lacquered in glossy anthracite (F7). From right to left, pillow 60x60 Goat 002 TJ0655-002-140 (S.6), Frozen CH 2928/076 (S.4) and Kravet 34213 C/16 (S.E).



1750 SOFA V2

SOFA 162 CM

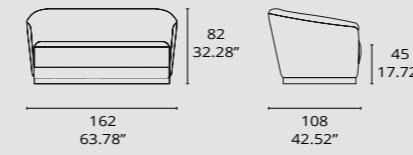

SOFA 202 CM

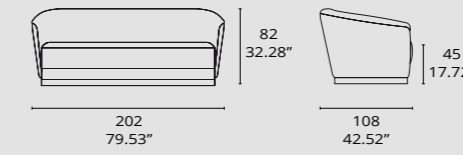

SOFA 242 CM

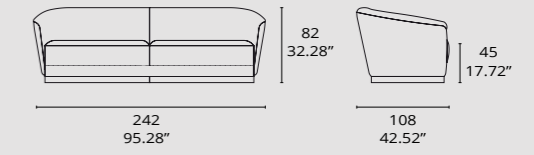

SOFA 282 CM

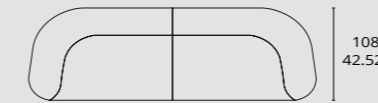
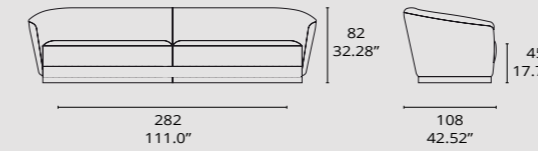

1752

1752 SOFÁ | SOFA
 1293 SILLÓN | ARMCHAIR
 4230/1 V1 MESA | TABLE
 4230/3 V3 MESA | TABLE
 4231/1 MESA | TABLE
 4231/3 MESA | TABLE



Sofá modular 1752 M1+M2+M3 (izqda.) combinando tela y piel en el tapizado. Almohadones de asiento, respaldo y brazo en tela Bespoke Oyster 132626 (S.9) y piel Ascot Pietra (S.17) en la base. **Sofá modular 1752** M4+M5 (derecha) en tela Garbo 39240712 (S.8). **Sillón 1293** (izqu.) con asiento y respaldo en piel Dalmata C/55 (S.11). Drcha, Asiento y respaldo en BW 1017 F0809/01 (S.9) con estructura lacada en Tinto brillo (F5). **Mesa 4230/1 V1** con estructura de acero bañada en latón envejecido. Tapa de cristal parsol 5+5. Color bronce. **Mesa 4231/1 Y 4231/3** con chapa de sicomoro frisé gris brillo (F4) y patas de acero bañado en latón envejecido. Tapa de la mesa con espejo tintado en gris.

Modular sofa 1752 M1+M2+M3 upholstered in fabric and leather. Base is upholstered in leather Ascot Pietra (S.17). Seat, back cushion and armrest is upholstered in fabric Bespoke Oyster 132626 (S.9). **Modular sofa 1752** M4+M5 (left) upholstered in fabric Garbo 39240712 (S.8). **Armchairs mod.1293** upholstered in leather Dalmata C/55 (S.11) (left) and fabric BW 1017 F0809/01 (S.9) (Right). The frame is lacquered in glossy red wine finish (F5). **Table 4230/1** with steel structure in old brass colour. Glass top in bronze colour. **Table mod.4231/1 and 4231/3** in glossy grey sycamore veneer (F4). The legs are in steel in old brass colour. Top with grey mirror.

1752

1752 SOFÁ | SOFA
 1293 SILLÓN | ARMCHAIR
 4231/1 MESA | TABLE
 4232/1 MESA | TABLE
 4232/3 MESA | TABLE



Sofá modular 1752 M4+M5 en tela Garbo 39240712 (S.8). **Sillón 1293** con asiento y respaldo tapizado en piel Dalmata C/55 (S.11) con estructura lacada en Tinto brillo (F5). **Mesa 4232/1** con patas en ecopiel Acua C/Arena 07 (S.2) y tapa en nogal natura (F1). **Mesa 4232/3** con patas en ecopiel Acua C/Mushroom 84 (S.2) y tapa de nogal natura (F1).

Modular sofa 1752 M4+M5 upholstered in fabric Garbo 39240712 (S.8). **Armchair mod.1293**. The seat and back cushion are upholstered in leather Dalmata C/55 (S.11). The frame is lacquered in glossy red wine finish (F5) **Table mod.4232/1** with upholstered legs in simil leather Acua C/Arena (S.2). Top is in nature walnut (F1). **Table mod.4232/3** with upholstered legs in simil leather Acua C/Mushroom 84 (S.2). Top is in nature walnut (F1).

1752

1752 SOFÁ | SOFA
4230/1 V3 MESA | TABLE



Sofá modular 1752 combinado en tela y piel con base tapizada en la piel Ascot Pietra (S.17) y Almohadones de asiento, respaldo y brazo tapizado en la tela Bespoke Oyster 132626 (S.9). Almohadillas, de derecha a izquierda, en telas Skintilla 132551 kingfisher (S.9), Skintilla 132550 Taupe (S.9) y Montecristo 3949 04 89 (S.8). **Mesa 4230/3 V2** con estructura de acero bañada en latón envejecido y tapa en nogal brillo (F4) . **Mesa 4230/3 V3** con estructura de acero bañada en latón envejecido y tapa de mármol negro marquina.

Modular sofa 1752 upholstered in fabric and leather. Base is upholstered in leather Ascot Pietra (S.17). Seat cushion, back cushion and armrest is upholstered in fabric Bespoke Oyster 132626 (S.9). Pillows, right to left, in fabric Skintilla 132551 Kingfisher (S.9), Skintilla 132550 Taupe (S.9) and Montecristo 3949 04 89 (S.8) **Table 4230/3 V2** with steel structure in old brass colour. Wooden top in glossy walnut (F4). **Table 4230/3 V3** with steel structure in old brass colour and Black marquina marble top.

1752 MODULAR SOFA

MÓDULOS SIN BRAZOS
MÓDULOS WITHOUT ARMREST

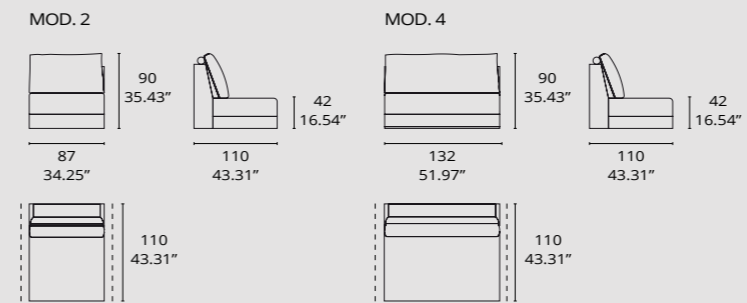

MÓDULOS CON BRAZOS
MÓDULOS WITH ARMREST

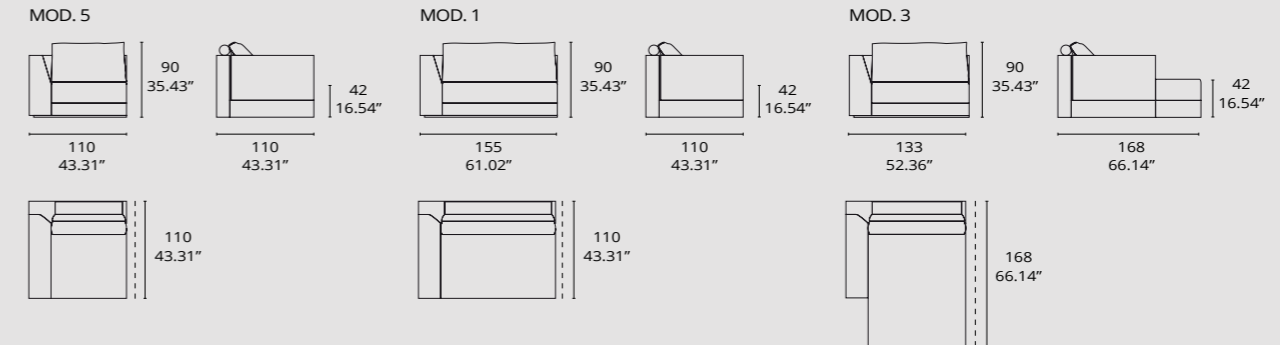

COMPOSICION | COMPOSITION

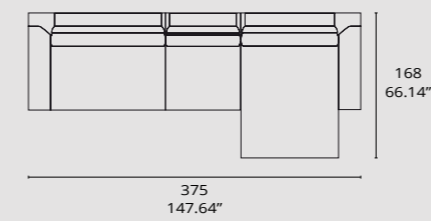

Notas de interés

Lh Arquitectura y Tecni Nova, s.l.u. dota de protección jurídica a sus creaciones, a través de la adquisición de derechos de Propiedad Industrial mediante la inclusión de sus productos en el Registro de los Dibujos y Modelos Industriales regulados en el Estatuto sobre Propiedad Industrial RDL 26 Julio de 1929 y el la Ley 11/1986 de 20 de Marzo de Patentes. Este sistema le permite ejercer sus derechos exclusivos sobre la fabricación, comercialización y difusión gráfica de sus registros y entablar cuantas acciones judiciales estime oportunas en defensa y contra el plagio que sobre sus modelos pudiese realizar cualquier tercero.

La empresa se reserva el derecho de hacer cualquier modificación sobre sus modelos, siempre que sea para mejora de los mismos.

Important notes

LH Arquitectura and Tecni Nova, s.l.u. provides judicial protection for its creations, through the acquisition of industrial property rights by means of the inclusion of this products in the Register of the desingns and industrial models regulated in the Statute on Industrial ownership Royal Decree Law, July 26, 1929 and Law 11/1986 dated March 20 of Patents. This system permits the exercising of exclusive rights of fabrication, commercialization and graphic dissemination of their records and to establish whatever judicial actions considered appropriate in defense of and against plagerism of their models that could be carried out by any third party.

The company reserves the right to make any modification to its mod els, on condition that this is in order to make improvements.



Spain

LH Arquitectura
C/ El Abeto 11. 46900 Torrent (Monte Real)
Valencia. Spain
email: lh@lharquitectura.com
phone: +34 960 061 914 - +34 656846700

China

16 Tiantaishan Road Wenzhou City
Zhejiang Province, China, 3250000

