



Luxury Homes
ARCHITECTURE & INTERIORS

SOFAS

SILLONES I ARMCHAIRS

POUFFS

MESAS I TABLES

SILLAS I CHAIRS

COMEDORES I DINING TABLES

MUEBLES I FURNITURE

DORMITORIOS I BEDROOMS

ESPEJOS I MIRRORS

ALMOHADILLAS I PILLOWS

EXTERIOR I OUTDOOR

ALMOHADILLAS I PILLOWS



1290 SILLÓN I ARMCHAIR
PAG. 102



1291 SILLÓN I ARMCHAIR
PAG. 106



1292 SILLÓN I ARMCHAIR
PAG. 108



1293 SILLÓN I ARMCHAIR
PAG. 112



1728 SILLÓN I ARMCHAIR
PAG. 116



1730 SILLÓN I ARMCHAIR
PAG. 118



1732 SILLÓN I ARMCHAIR
PAG. 120



1734 SILLÓN I ARMCHAIR
PAG. 122



1735 SILLÓN I ARMCHAIR
PAG. 126



1739 SILLÓN I ARMCHAIR
PAG. 128



1741 SILLÓN I ARMCHAIR
PAG. 130



1743 SILLÓN I ARMCHAIR
PAG. 134



1744 SILLÓN I ARMCHAIR
PAG. 138



1749 SILLÓN I ARMCHAIR
PAG. 142



1750 SILLÓN I ARMCHAIR
PAG. 146



1751 SILLÓN I ARMCHAIR
PAG. 150

1290

1290 SILLÓN | ARMCHAIR
1290 POUFF

Sillón 1290 con asiento y respaldo tapizado en piel Ascot C/ 814 Arena (S.17) y estructura de madera de roble barnizada en roble oscuro (F1). **Pouff 1290** tapizado en piel Ascot C/814 Arena (S.17) con base barnizada en roble oscuro (F1). El pouff incorpora ruedas.

Mod.1290 Armchair is upholstered in leather Ascot C/814 Arena (S.17). The frame are varnished in dark oak (F1).

Mod.1290 wheeled pouff is upholstered in leather Ascot C/ 814 Arena (S.17). Base is varnished in dark oak (F1).

1290

1290 SILLÓN | ARMCHAIR



Sillón 1290 con asiento tapizado en tela Style 1-3107-020 (S.4) y respaldo en la tela Dimension 1-3108-020 (S.9). Patas barnizadas en roble natura (F1).

Mod.1290 armchair. Seat is upholstered in fabric Style 1-3107-020 (S.4) . The backrest is upholstered in Dimension 1-3108-020 (S.9). Legs are varnished in natural oak (F1).

1290

SILLÓN
ARMCHAIR

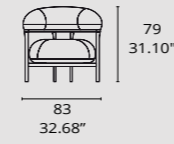

SILLA
CHAIR

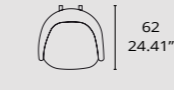
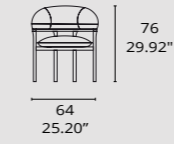

POUFF

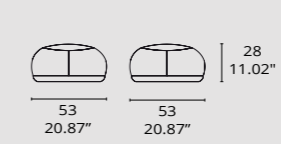

1291

1291 SILLÓN | ARMCHAIR
4162/32 MESA TREBOL | CLOVER TABLE
1716 SOFA



Sillón 1291 tapizado en tela Perino Velvet CA 1494/073 (S.4). Almohadilla en tela Goat 002 TJ0655-002-140 (S.6). **Mesa 4162** lacada en azul brillo (F5).

Armchair mod.1291 Armchair upholstered in fabric Perino Velvet CA 1494/073 (S.4). Pillow in fabric Goat 002 TJ0655-002-140 (S.6) **Table mod.4162** is lacquered in glossy blue (F5).

1291

SILLÓN | ARMCHAIR

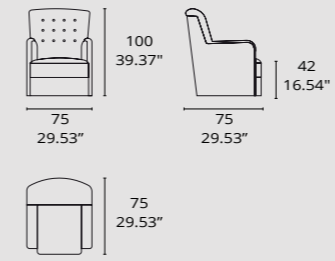

1292

1292 SILLÓN | ARMCHAIR

4230/1 V1 MESA | TABLE

4231/1 MESA | TABLE

4231/14 APARADOR | SIDEBBOARD



Sillón 1292 con base en tela Crafty CH2935/060 (S.3). Respaldo y almohadón de asiento en tela Pastel Poetry CH2890/063 (S.3) con estructura de madera de iroko y acabado natural (F1). **Mesa 4230/1 V1** con estructura de acero bañada en latón envejecido y tapa de cristal en color bronce.

Armchair mod. 1292. The base is upholstered in fabric Crafty CH2935/060 (S.3). Back and seat cushions are upholstered in fabric Pastel Poetry CH-2890/063 (S.3). All the frame is in iroko wood with natural finish (F1). **Table mod.4230/1 V1** with steel structure in old brass colour. Glass top in bronze colour.

1292

1292 SILLÓN | ARMCHAIR



1292

SILLÓN
ARMCHAIR

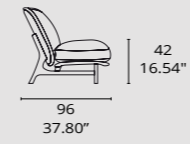
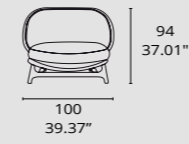

TUMBONA

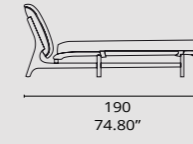
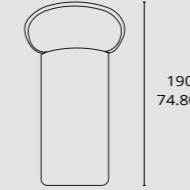
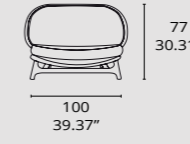

1293

1293 SILLÓN | ARMCHAIR
 1748 POUFF
 4230/1 V2 MESA | TABLE



Sillón 1293 (izqu.) con asiento y respaldo en piel Dalmata C/55 (S.11). Drcha Asiento y respaldo en tela BW 1017 F0809/01 (S.9). La estructura del sillón está lacada en Tinto brillo (F5). **Mesa 4230/1 V2** con estructura de acero bañada en latón envejecido y tapa en nogal brillo (F4). **Pouff 1748** con capitoné tapizado en la piel Firenze Pietra (S.11).

Armchair mod.1293 (left) the seat and back cushion are upholstered in leather Dalmata C/55 (S.11). (Right) the seat and back cushion are upholstered in fabric BW 1017 F0809/01 (S.9). The frame is lacquered in glossy red wine finish (F5). **Table mod.4230/1 V2** with steel structure in old brass colour. Wooden top in glossy walnut (F4). **Mod.1748 pouff** with buttons upholstered in leather Firenze Pietra (S.11).

1293

1293 SILLÓN | ARMCHAIR



1293

SILLÓN | ARMCHAIR

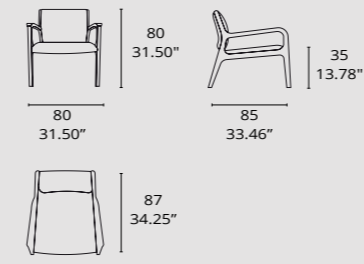

1728

1728 SILLÓN | ARMCHAR
 1290 POUFF
 4162 MESA | TABLE
 4233/14 APARADOR | SIDEBBOARD

Sillón 1728 tapizado en la piel Firenze C/Pepper (S.11). La **mesa 4162** con forma de trébol está toda lacada en mostaza brillo (F5). **Aparador bajo 4233/7** con estructura de madera de roble natura y cajones y parte trasera lacados en mostaza brillo (F3).

Armchair mod.1728 upholstered in leather Firenze C/ Pepper (S.11). **Mod.4162 clover table** is lacquered in glossy mustard. **Living sideboard mod.4233/7** with oak frame in varnished in natural oak and glossy mustard (F3).

1728

SILLÓN | ARMCHAIR

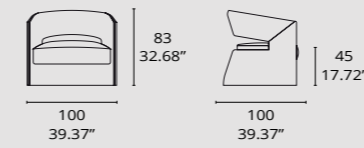

SILLA | CHAIR

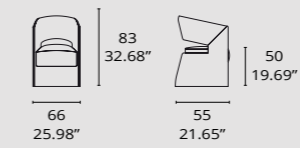

1730

1730 SILLÓN | SILLÓN
4207/3 MESA | TABLE

Sillón 1730 giratorio tapizado en tela y piel. Base del sillón tapizada en piel Ascot Topo (S.17) e interior, junto con el almohadón de respaldo y asiento tapizados en tela Avant Gardiste CA 1361/080 (S.8) con patas lacadas en marrón brillo (F5). **Mesa 4207/3** lacada en marrón brillo y nogal natura (F5). La tapa de la mesa es de cristal.

Swivel armchair mod.1730 in leather Ascot Topo (S.17) and fabric Avant Gardiste CA1361/080 (S.8). The legs are lacquered in glossy brown (F5). **Table mod.4207/3** with glass top is lacquered in glossy brown and nature walnut (F5).



1730

SILLÓN | ARMCHAIR

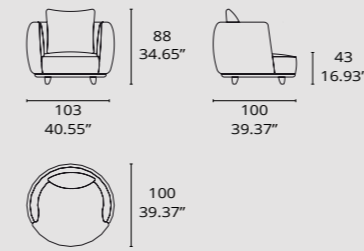



1732

1732 SILLÓN | SILLÓN

1732

SILLÓN | ARMCHAIR

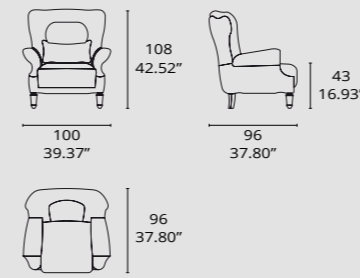

120

121

Sillón 1732 con base y respaldo tapizados en la piel Interludio C/52 Burdeos (S.11) y asiento en la tela Vegas Velvet Plain Dis 1403 C/47 (S.6). Patas tapizadas con decoración metálica.

Armchair mod.1732, back part with buttons, upholstered in leather Interludio C/52 Burdeos (S.11). Seat and interior back in fabric Vegas Velvet Plain Dis 1403 C/47 (S.6). Legs upholstered with metal details.



1734

1734 SILLÓN | SILLÓN

1734 POUFF

4162 MESA | TABLE



Sillón 1734 tapizado en la tela Axum C/29 (S.6). La almohadilla con bordado en tela Frozen Harmony CH 2929/021 (S.3). Patas acabadas en marrón brillo (F5). **Pouff 1734** tapizado en la piel Ascot Cobalto (S.17) con patas acabadas en marrón brillo (F5). **Mesa 4162** lacada en azul brillo (F5).

Armchair mod.1734 is upholstered in fabric Axum C/29 (S.6). Pillow is upholstered in fabric Frozen Harmony CH 2929/021 (S.3) with logo. The legs are lacquered in glossy brown (F5). **Pouff mod.1734** upholstered in leather Ascot Cobalto (S.17). The legs lacquered in glossy brown (F5). **Table mod. 4162** is lacquered in glossy blue (F5).

1734

1734 SILLÓN | SILLÓN



Sillón 1734 tapizado en tela Axum C/29 (S.6). Detalle de almohadilla. Tapizada en la tela Frozen Harmony CH 2929/021 (S.3). Logo bordado sobre piel Firenze C/ Pepper (S.11).

Armchair mod.1734 is upholstered in fabric Axum C/29 (S.6). Pillow is upholstered in fabric Frozen Harmony CH2929/021 (S.3) with logo in Firenze Pepper (S.11).

1734

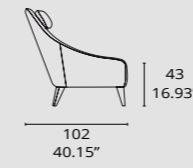
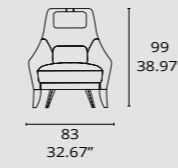
SILLÓN
ARMCHAIR

POUFF

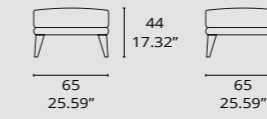

1735

1735 SILLÓN | ARMCHAIR



1735 sillón Chester tapizado en tela y piel. Toda la base está tapizada en la piel Savana Moka (S.10). El asiento y las almohadillas están tapizados en la tela Mellite 3507 0202 (S.9).

1735 armchair Chester upholstered in fabric leather. The base of sofa is upholstered in leather Savana Moka (S.10). The seat cushion, back cushion and pillows are upholstered in Mellite 3507 0202 fabric (S.9).

1735

SILLÓN | ARMCHAIR

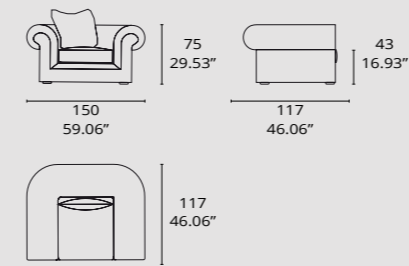

1739

1739 SILLÓN | ARMCHAIR

1739 POUFF

4216/16 LIBRERÍA | BOOKCASE

Sillón 1739 tapizado en tela Texas 5 (S.2) y Pastel Poetry CH2829/024 (S.3). La tela de la almohadilla es Zenith Cinnabar 9019/05 (S.E). **Pouff 1739** tapizado en las mismas telas que el sillón. La **librería 4216/16** tiene el interior tapizado en la tela Teji Chic Miel (S.4). La estructura de madera está lacada en antracita mate (F4). Incluye estanterías de cristal. Pag. sigu. **Sillón 1739** interior en Global Friend CH1844-070 (S.3) y base en Aniline Stone 07 (S.2).

Mod.1739 armchair in fabric Texas 5 (S.2) and Pastel Poetry CH 2829/024 (S.3). The pillow's fabric is Zenith Cinnabar 9019/05 (S.E). **1739 pouff** is upholstered in the same fabrics than the armchair. **4216/16 bookcase** has the interior upholstered in Teji Chic Miel (S.4) (technical fabric). The wooden structure is lacquered in anthracite matt (F4). Glass shelves are included. Next page. **1739 armchair** interior in Global Friend CH1844-070 (S.3) and base in Aniline Stone 07 (S.2).

1739

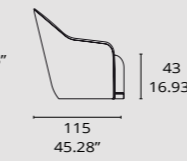
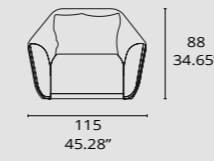
SILLÓN
ARMCHAIR

POUFF

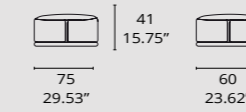

1741

1741 SILLÓN | ARMCHAIR
4233/7 APARADOR BAJO | LIVING SIDEBOARD
4230/3 V3 MESA | TABLE

Sillón 1741 tapizado en la tela Bruma C/402 (S.4) con patas lacadas en antracita mate (F4). **Aparador bajo 4233/7** acabado en sicomoro gris brillo (F5). **Mesa 4230/3 V3** con estructura de acero bañada en latón envejecido y tapa de mármol negro.

Mod.1741 armchair is upholstered in fabric Bruma C/402 (S.4). Legs are laquered in matt anthracite (F4). **Mod.4233/7 living sideboard** in grey glossy sycamore (F5). **Mod.4230/3 V3 table** with steel structure plated in old brass with black marble top.

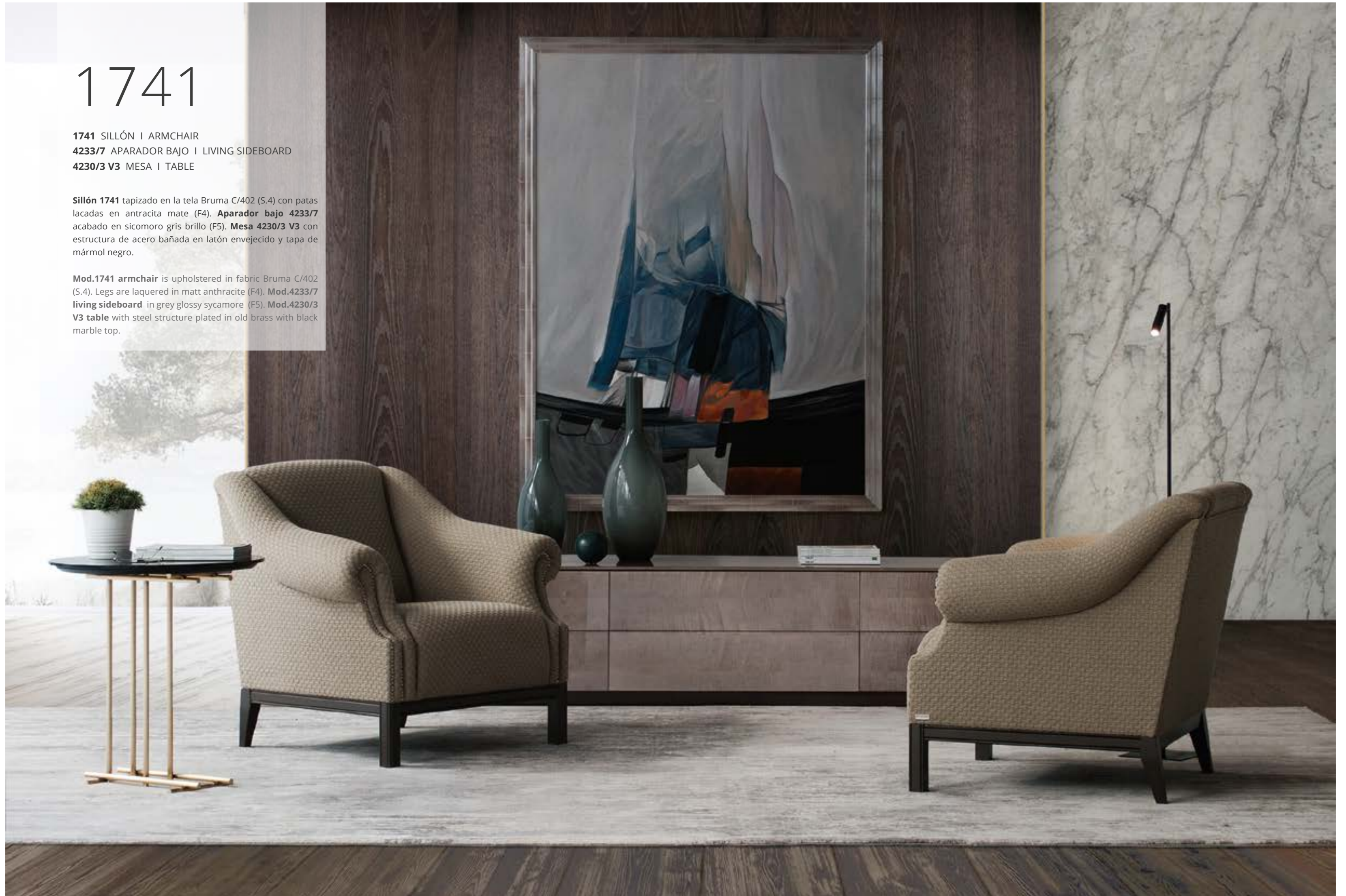

1741

1741 SILLÓN | ARMCHAIR



Detalles del **sillón 1741** tapizado en la tela Bruma C/402 (S.4) con patas lacadas en antracita mate (F4).

1741 armchair details is upholstered in fabric Bruma C/402 (S.4). Legs are laquered in matt anthracite (F4).

1741

SILLÓN | ARMCHAIR

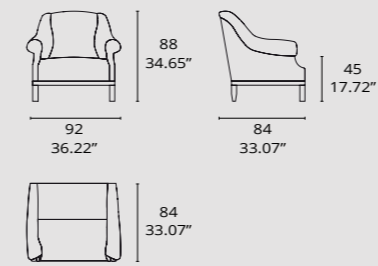

1743

1743 SILLÓN | ARMCHAIR
 4220/7 APARADOR BAJO | LIVING SIDEBBOARD
 4220/1 MESA | TABLE
 4225/16 LIBRERÍA | BOOKCASE



Sillón 1743 tapizado en tela y piel. La base del sillón está tapizada en piel Firenze Pietra (S.11). El interior, respaldo y asiento tapizado con la tela Mara 42 SR-3-72842/14 (S.2). Almohadilla en tela Buckingham C/6 (S.8). Patas lacadas en antracita brillo (F7). **Aparador bajo 4220/7** con estructura de madera y lacado en antracita brillo (F7). La tapa está tapizada en la piel Dalmata C/92 (S.11).

Armchair mod.1743 upholstered in fabric and leather. Base in leather Firenze Pietra (S.11). Interior, back cushion and seat cushion are in fabric Mara 42 SR-3-72842/14 (S.2). The pillow is Buckingham C/6 (S.8). The legs of armchairs are lacquered in glossy anthracite (F7). **TV Cabinet mod.4220/7** is lacquered in glossy anthracite (F7). Top is upholstered in leather Dalmata C/92 (S.11).

1743

1743 SILLÓN | ARMCHAIR



Detalle de combinación de tela Mara 42 SR-3-72842/14 (S.2) con piel Firenze Pietra (S.11) y almohadilla Buckingham C/6 (S.8).

Fabric details in Mara 42 SR-3-72842/14 (S.2) with leather Firenze Pietra (S.11) and pillow Buckingham C/6 (S.8).

1743

SILLÓN | ARMCHAIR

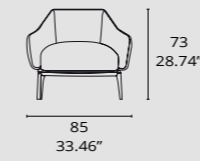

POUFF

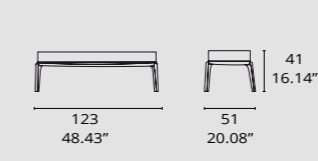

1744

1744 SILLÓN | ARMCHAIR
4221/4 MESA | TABLE

Sillón giratorio 1744 (izq.) Base del sillón tapizada en piel Nature Col.1125 (S.12) e interior en tela Passion C/3 (S.4). Asiento y almohadón de respaldo en la tela Intreccio C/3 (S.8) con base giratoria de madera lacada en bronce brillo (F7).

Sillón giratorio 1744 (dcha.). Base del sillón en piel Cavallino C/4 (S.19) e interior del sillón está en tela Passion C/3 (S.4). Asiento y almohadón de respaldo en tela Intreccio C/3 (S.8). La base giratoria de madera está lacada en bronce brillo (F7).

Mesa 4221/4 lacada en cobre brillo con tapa barnizada en nogal brillo (F7).

Swivel armchair mod.1744 (left). Armchair base is in leather Nature Col.1125 (S.12). Interior of armchair is upholstered in fabric Passion C/3 (S.4). Seat and back cushions are upholstered in fabric Intreccio C/3 (S.8). The wooden swivel base is lacquered in glossy bronze (F7).

Swivel armchair mod.1744 (right). Armchair base is in leather Cavallino C/4 (S.19). Interior of armchair is upholstered in fabric Passion C/3 (S.4). Seat and back cushions are upholstered in fabric Intreccio C/3 (S.8). The wooden swivel base is lacquered in glossy bronze (F7).

Table mod.4221/4 is lacquered in glossy copper. Top is varnished in glossy walnut (F7).



1744

1744 SILLÓN | ARMCHAIR
4221/4 MESA | TABLE

Sillón giratorio 1744. Base del sillón tapizada en piel Nature Col.1125 (S.12). Interior del sillón tapizado en la tela Passion C/3 (S.4) y asiento y almohadón de respaldo tapizados en tela Intreccio C/3 (S.8) con base giratoria de madera está lacada en bronce brillo (F7).

Swivel armchair mod.1744. Armchair base is in leather Nature Col.1125 (S.12). Interior of armchair is upholstered in fabric Passion C/3 (S.4). Seat and back cushions are upholstered in fabric Intreccio C/3. The wooden swivel base is lacquered in glossy bronze (F7).



1744

SILLÓN | ARMCHAIR

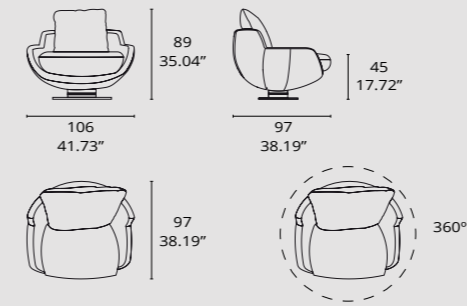

1749

1749 SILLÓN | ARMCHAIR
1749 POUFF



Sillones giratorios 1749 tapizados en tela Pougy Z475/06 Cocktail (Naranja) (S.7). Tela Pougy Z475/02 Linen (S.7) (Beige), ambas con cerco en cobre brillo (F7). Sillón tapizado en tela Beaux Z474/03 Affogato (negra) (S.9) con cerco lacado en antracita brillo (F7). **Pouff giratorio 1749** tapizado en piel Dalmata C/91 (S.11) con cerco lacado en cobre brillo (F7). El giro de radio del pouff es excéntrico.

Swivel armchairs mod.1749 upholstered in fabric. (Orange) Seat and back upholstered in Pougy z475/06 Cocktail (S.7). (Beige) Armchair upholstered in fabric Pougy Z475/02 Linen (S.7). The base is lacquered in glossy copper (F7). (Black) upholstered in fabric Beaux Z474/03 Affogato (S.9). The base is lacquered in glossy anthracite (F7). **Swivel pouff mod.1749** upholstered in leather Dalmata c/91 (S.11). The swivel base is in glossy copper (F7).

1749

1749 SILLÓN | ARMCHAIR
4227/32 MESA | TABLE

Detalle **sillón giratorio 1749** tapizados en tela Beaux Z474/03 Affogato (S.9) con cerco giratorio está lacado en antracita brillo (F7).

Details **swivel armchair mod.1749** upholstered in fabric. (Black) upholstered in fabric Beaux Z474/03 Affogato (S.9). The base is lacquered in glossy anthracite (F7).



1749

SILLÓN | ARMCHAIR

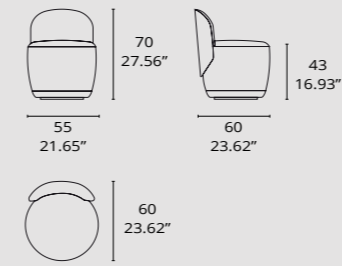

1750

1750 SILLÓN | ARMCHAIR

4233/14 APARADOR | SIDEBOARD

4233/15 VITRINA | CUPBOARD

4230/1 MESA | TABLE



Sillón 1750 tapizado en tela Lorenzo 1-3129-031 (S.5). Toda la parte trasera del sillón está realizada mediante pliegues de la tela. Zócalo de madera oro patina brillo (F7). **Aparador 4233/14** y **vitrina 4233/15** con acabados cobre brillo, ébano brillo y roble oscuro (F6).

Armchairs mod.1750 upholstered in fabric Lorenzo 1-3129-031 (S.5). All the backside part is with folds. The wooden base is in glossy gold patina (F7). **Mod.4233/14 sideboard** and **Mod.4233/15 cupboard** with exterior structure lacquered in glossy copper and front and back is in glossy ebony (F6).

1750

1750 SILLÓN | ARMCHAIR

Detalles del **sillón 1750** tapizado en la tela Lorenzo 1-3129-031 (S.5). Foto dcha. Detale de la parte trasera del sillón tapizada mediante el plegado de la tela. Almohadilla en tela Maroque Meteor 9035/01 (S.E).

Armchair details mod.1750 upholstered in fabric Lorenzo 1-3129-031 (S.5). Details backside part with folds. The wooden base is in brass (F7). Pillow Maroque Meteor 9035/01 (S.E).



1750

SILLÓN | ARMCHAIR

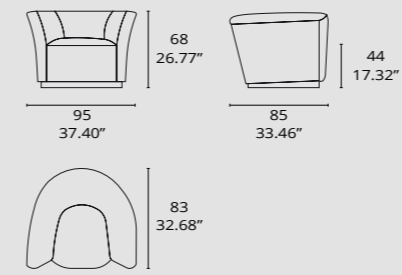

1751

1751 SILLÓN | ARMCHAIR
 4233/14 APARADOR BAJO | LIVING SIDEBOARD
 1748 POUFF
 4226 V2 MESA | TABLE



Sillón 1751 tapizado en tela Lennox 1-6847-190 (S.2) y patas lacadas en wengue (F1). **Aparador bajo 4233/7** con estructura exterior lacada en cobre brillo con frentes de los cajones y parte trasera en ébano brillo (F6). El **puoff 1748** está tapizado en capitoné con la piel Savana C/Pietra (S.10). **Mesa 4226 V2** es una pieza torneada lacada en cobre brillo y barnizada en nogal natura. La tapa es de mármol blanco macael.

Armchair mod.1751 upholstered in fabric Lennox 1-6847-190 (S.2), legs are lacquered in wenge (F1). **Living sideboard mod.4233/7** is lacquered in glossy copper with the front of drawers and the back part are in ebony veneer with a glossy finish (F6). **Pouff 1748** is with buttons in leather Savana C/Pietra (S.10). **Table mod.4226 V2** is in natural walnut and lacquered in glossy copper, with macael marble top.

1751

1751 SILLÓN | ARMCHAIR



Detalles **Sillón 1751** tapizado en tela Lennox 1-6847-190 (S.2). Las patas están lacadas en wenguey (F1).

Armchair mod.1751 details upholstered in fabric Lennox 1-6847-190 (S.2), legs are varnished in wengey (F1).



1751

SILLÓN | ARMCHAIR

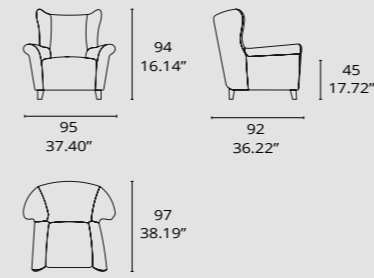

Notas de interés

Lh Arquitectura y Tecni Nova, s.l.u. dota de protección jurídica a sus creaciones, a través de la adquisición de derechos de Propiedad Industrial mediante la inclusión de sus productos en el Registro de los Dibujos y Modelos Industriales regulados en el Estatuto sobre Propiedad Industrial RDL 26 Julio de 1929 y el la Ley 11/1986 de 20 de Marzo de Patentes. Este sistema le permite ejercer sus derechos exclusivos sobre la fabricación, comercialización y difusión gráfica de sus registros y entablar cuantas acciones judiciales estime oportunas en defensa y contra el plagio que sobre sus modelos pudiese realizar cualquier tercero.

La empresa se reserva el derecho de hacer cualquier modificación sobre sus modelos, siempre que sea para mejora de los mismos.

Important notes

LH Arquitectura and Tecni Nova, s.l.u. provides judicial protection for its creations, through the acquisition of industrial property rights by means of the inclusion of this products in the Register of the desingns and industrial models regulated in the Statute on Industrial ownership Royal Decree Law, July 26, 1929 and Law 11/1986 dated March 20 of Patents. This system permits the exercising of exclusive rights of fabrication, commercialization and graphic dissemination of their records and to establish whatever judicial actions considered appropriate in defense of and against plagerism of their models that could be carried out by any third party.

The company reserves the right to make any modification to its mod els, on condition that this is in order to make improvements.



Spain

LH Arquitectura
C/ El Abeto 11. 46900 Torrent (Monte Real)
Valencia. Spain
email: lh@lharquitectura.com
phone: +34 960 061 914 - +34 656846700

China

16 Tiantaishan Road Wenzhou City
Zhejiang Province, China, 3250000

