

HOME PHILOSOPHY
visionnaire

B E A U T Y

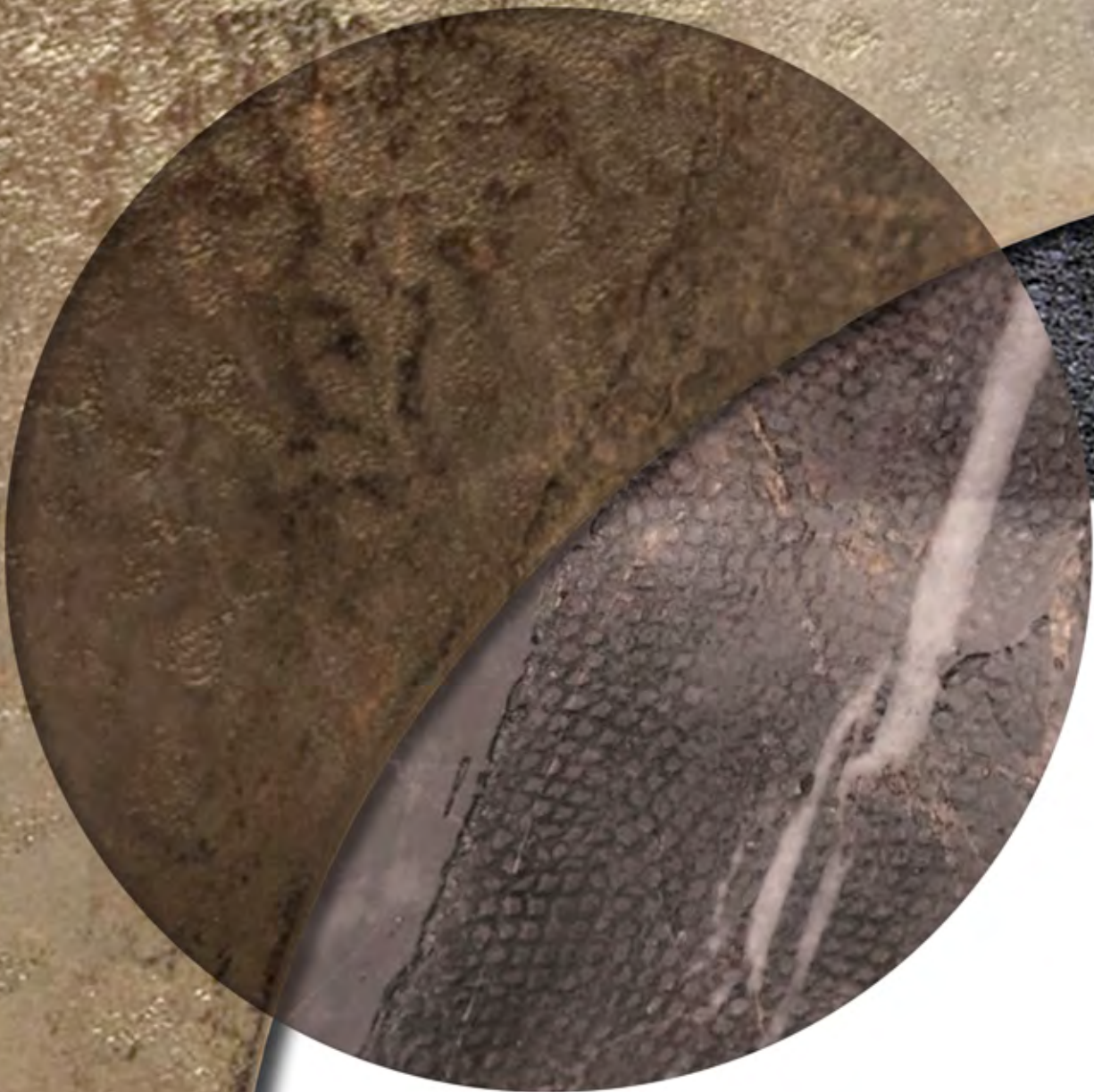



ULTRASOUND BEDROOM



ULTRASOUND BEDROOM









ULTRASOUND BEDROOM



ULTRASOUND BEDROOM

ULTRASOUND LARGE bed

Padded bed upholstered in leather or fabric; headboard consisting of poplar plywood and padded bands upholstered one by one, creating a high-relief three-dimensional pattern, decorated with metal friezes in polished stainless steel. Headboard to be wall mounted. Bedframe with structure in plywood, padded with polyurethane foam and covered with a quilted upholstery. Bed provided disassembled (headboard divided in 2 pieces, bedframe in 3 pieces). Plinth in polished stainless steel. Wooden slats sustained by four adjustable corner brackets in metal and a central rod. Metal components can be finished with any of the lacquers included in the metal finishes selection.





Lawrence 24313/16 Beola

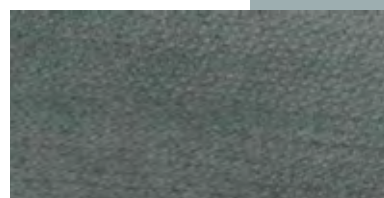

Taras 24296/24 Asparago

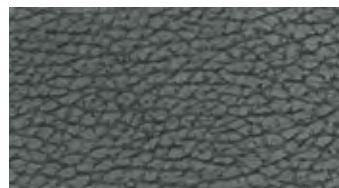

Confusion Dark marble



Champagne lacquered steel



ULTRASOUND LARGE
design Alessandro La Spada

bed
330x228 H.132 cm

Padded bed upholstered in fabric Lawrence 24313/16 Beola. Headboard composed by bands, padded one by one, creating a three-dimensional motif, metal profiles and base with polished champagne-lacquered finish. Wooden slats.

ULTRASOUND
design Alessandro La Spada

bedside table
Ø50 H.50 cm

Round bed-side table with door upholstered in leather Taras 24296/24 Asparago. External structure in curved multi-layered wood covered with diagonal bands, padded one by one and upholstered. Top in marble Confusion Dark. Internally equipped with shelf. Base in stainless steel with polished champagne-lacquered finish.

In the Ultrasound bed-side table the cylindric design drives the technical features of this item of furniture. Its curved door opens on to an internal shelf positioned in the upper part of the night table, saving space and providing larger storage capability. The external upholstery in leather or fabric is decorated with oblique bands, slightly padded and covered one by one, reproducing Ultrasound graphic motif. This graphic pattern makes it a perfect match with other pieces of Visionnaire furniture collection.

MILLER
sofa

Lawrence 24313/16 Beola

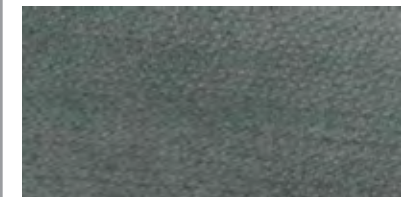

Lawrence 24313/17 Silver



Gold lacquered steel



MILLER
design Fabio Bonfa

sofa
200x90 H.85 cm

Sofa upholstered in fabric Lawrence 24313/17 Silver. Curved back cushion upholstered in fabric Lawrence 24313/16 Beola with cannetté quilting. Loose cushions 40x40 cm in fabric Lawrence 24313/17 Silver. Steel profile with polished gold-lacquered finish.

K O B O L

make-up unit

K O B O L

design Alessandro La Spada

make-up unit
165x55 H.143 cm

Make-up unit with two drawers. Structure in polished champagne-lacquered steel. External structure and drawer fronts in wood lacquered in shiny NCS S 7005-B20G, internal structure covered in polished champagne-lacquered steel. Top in marble Crystal Juliet. The bottom of the top is equipped with "secret" doors and mirror in lacquered wood with LED light strips. Desk pad in leather Kale 24135/02 Charcoal.



Crystal Juliet marble



NCS S 7005 - B20G



Gold satinized steel



LEONARDO
chest of drawers

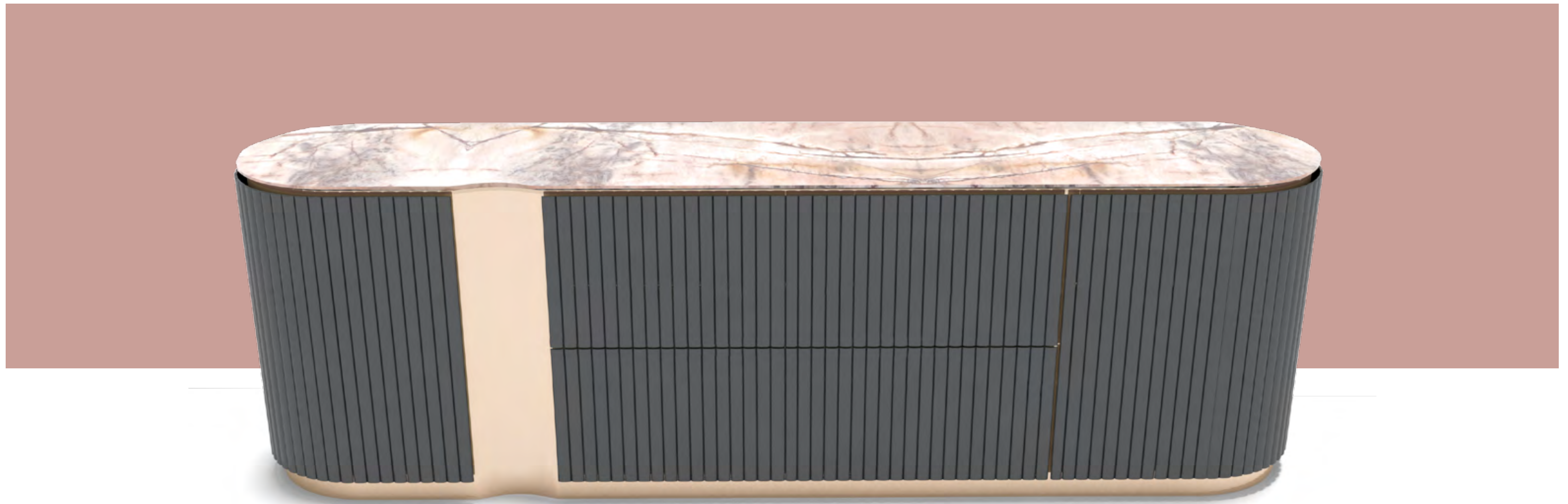

LEONARDO
design Alessandro La Spada

chest of drawers
240x50 H.65 cm

Top in shaped marble Crystal Juliet.
Structure in wood with canneté
decoration, lacquered in shiny NCS S
7005 - B20G. Lateral compartments
with shelf divided in sections covered
in flock. Plinth, under-top profile and
vertical insert in steel with polished
champagne-lacquered finish.

Crystal Juliet marble



NCS S 7005 - B20G



Champagne lacquered steel



FLORO

lightings

Lamp with stem consisting of lighting elements composed by two capsules in blown glass, decorated with particles of gold leaf. The glass diffusers are encased in a precious laser-cut supporting structure. The gold leaf blown together with the glass makes every piece unique and precious. The metal structure reminds of a jewel, combining its supporting and aesthetic function.

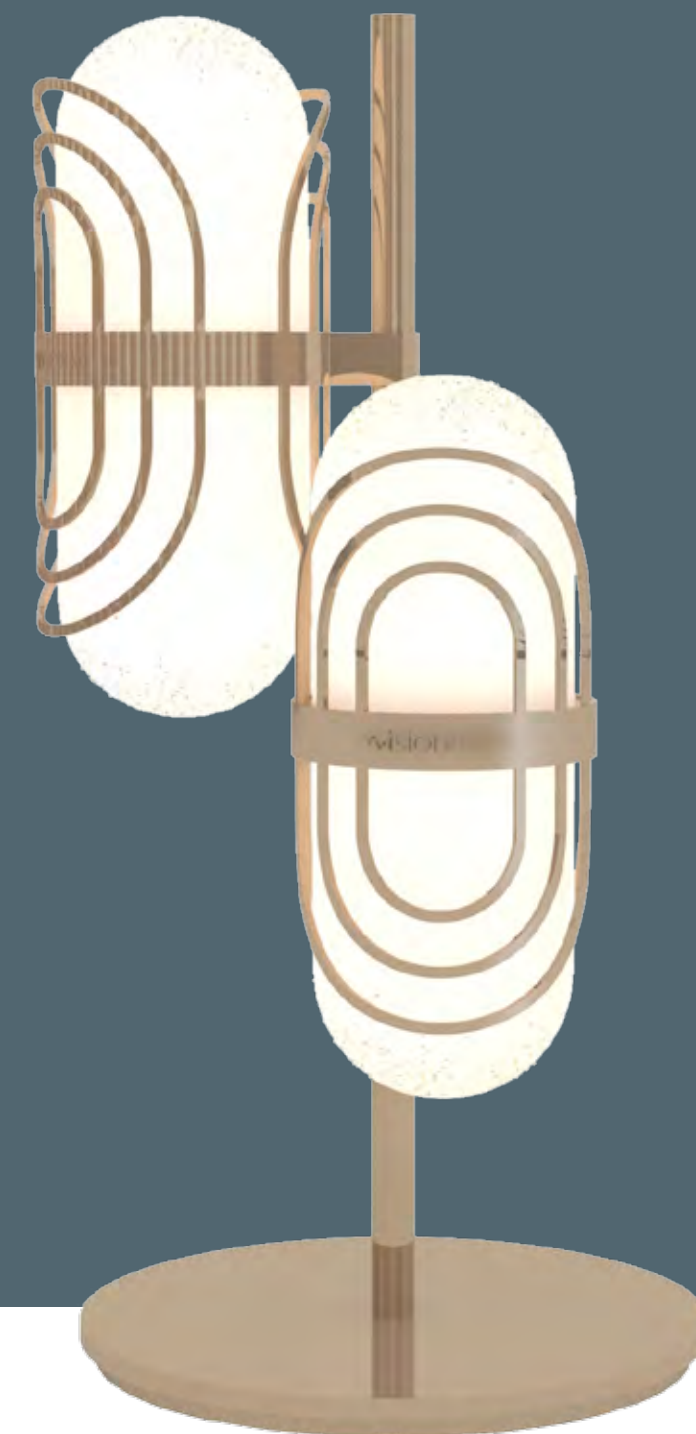

FLORO
design Alessandro La Spada

table lamp
32x30 H.65 cm

Structure in steel with polished champagne-lacquered finish. Diffuser in hand-made blown glass with satin opaline finish and dispersion covered in gold-leaf.

F L O R O
design Alessandro La Spada

Ceiling lamp - wall lamp
Ø42 H.140 cm - 14x19 H.35 cm

Structure in steel with polished champagne-lacquered finish. Diffuser in hand-made blown glass with satin opaline finish and dispersion covered in gold-leaf.

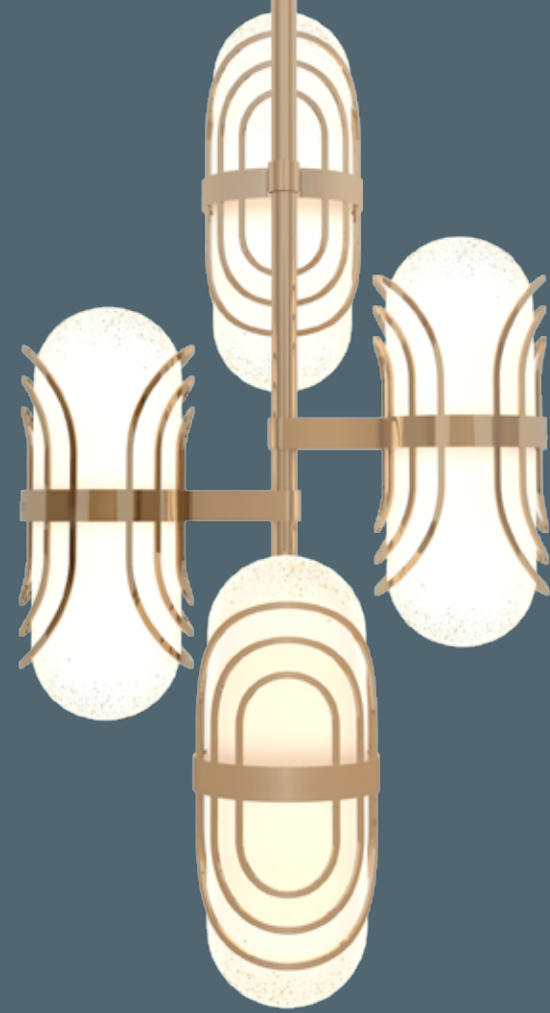

F L O R O
design Alessandro La Spada

Floor Lamp
Ø35 H.160 cm

Structure in steel with polished champagne-lacquered finish. Diffuser in hand-made blown glass with satin opaline finish and dispersion covered in gold-leaf.



A K I R A
lightings

Soft 1118 Canapa

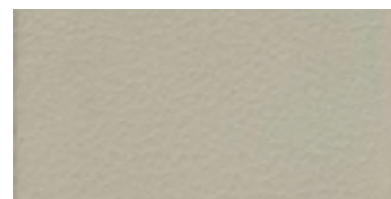

Champagne lacquered steel



A K I R A
design Alessandro La Spada

abat-jour
33x11 H.51 cm

Lampshade with fan-shape in leather Soft 1118 Canapa with Ultrasound embroidery. Lamp-holder in turned brass with diffuser in satin glass. Base in brass with polished champagne-lacquered finish.

FIDELIO mirror

Vertical mirror characterised by a concave back in wood covered with a steel sheet decorated with a digitally printed marble-effect graphic. The curve shape of the steel cover highlights the scenic effect bestowed by this mirror on to the room. The light positioned between the mirror and the concave surface stresses the unique design of these surfaces.



FIDELIO design Alessandro La Spada

mirror
100x11 H.130 cm

Back structure in metal decorated with a high-resolution marbled printing. Suspended central mirror equipped with back-lit LED light.

S O F F I O
art work



S O F F I O n 1 6 . 1 7
design CaCo3

art work
75 x 35 x 4 cm

Glass paste with white golden leaf,
mineral oxide and mortar, iron frame.



S O F F I O n 2 0
design CaCo3

art work
60 x 50 x 4 cm

Glass, mineral oxide and mortar, iron
frame.

ALVEOLIZZAZIONE

art work



SOFFIO n15

design CaCo3

art work
60 x 60 x 4 cm

Limestone, mortar and stucco, iron
frame.

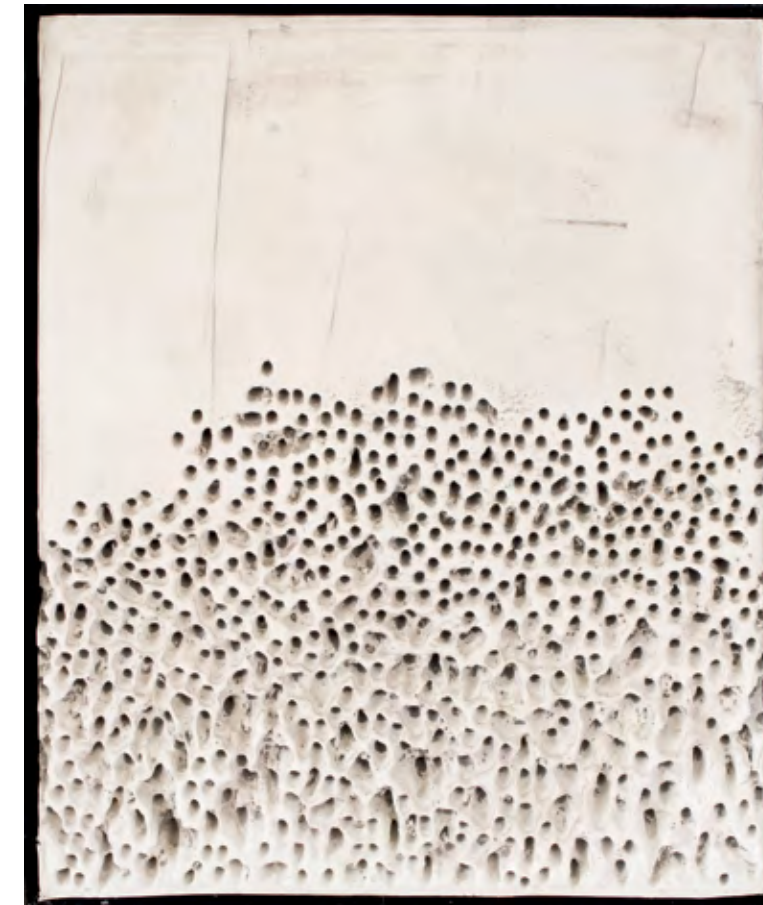

ALVEOLIZZAZIONE

design CaCo3

art work
50 x 60 x 4 cm

Mortar, iron.

PHILIDOR
design Alessandro La Spada

carpet
250x350 cm

Hand-tufted carpet in bamboo silk
and New Zealand wool with hand-
carving decoration. Backing in cotton.



PHILIDOR
carpet

*Carpet with a unique design made in soft bamboo silk;
high-density surface decorated with an "engraved" motif.
The Ultrasound graphic is designed by means of tiny
canyons in wool and lurex running through the surface of
the carpet, combining design with the comfort typical of
Visionnaire products.*

01. ULTRASOUND LARGE

Letto 330x228 H.132 cm. Rivestito in tessuto, Lawrence 24313/16 Beola. Testata composta da fasce imbottite e tappezzate singolarmente, a formare un motivo tridimensionale ad alto spessore completato da profili e basamento metallico in finitura Champagne lucido. Rete a doghe.

Bed 330x228 H.132 cm. Padded bed upholstered in fabric Lawrence 24313/16 Beola. Headboard composed by bands, padded one by one, creating a three-dimensional motif, metal profiles and base with polished champagne-lacquered finish. Wooden slats.

02. ULTRASOUND

Comodino Ø50 H.50 cm. Comodino tondo con anta tappezzata in pelle Taras 24296/24 Asparago. cocca in legno multistrati curvato imbottito a fasce diagonali singolarmente tappezzate. Top in marmo Confusion Dark. Interno con ripiano di cortesia. Basamento in acciaio, finitura Champagne lucido.

Bed-side table Ø50 H.50 cm. Round bed-side table with door upholstered in leather Taras 24296/24 Asparago. External structure in curved multi-layered wood covered with diagonal bands, padded one by one and upholstered. Top in marble Confusion Dark. Internally equipped with shelf. Base in stainless steel with polished champagne-lacquered finish.

03. MILLER

Divano 200x90 H.85 cm. Divano tappezzato in tessuto Lawrence 24313/17 Silver. Rivestimento schienale curvo in tessuto Lawrence 24313/16 Beola con lavorazione cannettè. Cuscini volanti 40x40 cm in tessuto Lawrence 24313/17 Siver. Profilo in acciaio, finitura Oro lucido.

Sofa 200x90 H.85 cm. Sofa upholstered in fabric Lawrence 24313/17 Silver. Curved back cushion upholstered in fabric Lawrence 24313/16 Beola with cannettè quilting. Loose cushions 40x40 cm in fabric Lawrence 24313/17 Siver. Steel profile with polished gold-lacquered finish.

04. KOBOL

Make-up unit 200x65 H.90 cm. Mobile trucco a due cassetti. Struttura in acciaio champagne lucido. Scocca e frontali cassetti in legno laccato NCS S 7005-B20G lucido, internamente rivestita in acciaio champagne lucido. Top in marmo Crystal Juliet. Sul fondo del top sono presenti sportelli "segreti" e specchio in legno laccato con fascia luminosa a LED. Sottomano in pelle Kale 24135/02 Charcoal.

Make-up unit with two drawers. Structure in polished champagne-lacquered steel. External structure and drawer fronts in wood lacquered in shiny NCS S 7005-B20G, internal structure covered in polished champagne-lacquered steel. Top in marble Crystal Juliet. The bottom of the top is equipped with "secret" doors and mirror in lacquered wood with LED light strips. Desk pad in leather Kale 24135/02 Charcoal.

05. CLOUD

Sedia 64x57 H.81 cm. Rivestimento seduta e schienale in pelle Soft Leather 280 Argilla con ricamo "Cà Foscarì" sul retro dello schienale. Struttura in acciaio in finitura Champagne lucido.

Chair 64x57 H.81 cm. Seat and back upholstered in leather Soft 280 Argilla with "Cà Foscarì" embroidery on the rear back. Structure in steel with polished champagne-lacquered finish.

06. LEONARDO

Cassettiera 240x50 H.65 cm. Top in marmo sagomato Crystal Juliet. Struttura in legno con lavorazione cannettè laccata NCS S 7005 - B20G lucido. Vani d'estremità con ripiano a comparti floccato. Zoccolo, profilatura sottotop e inserto verticale in acciaio, finitura Champagne lucido.

Chest of drawers 240x50 H.65 cm. Top in shaped marble Crystal Juliet. Structure in wood with cannettè decoration, lacquered in shiny NCS S 7005 - B20G. Lateral compartments with shelf divided in sections covered in flock. Plinth, under-top profile and vertical insert in steel with polished champagne-lacquered finish.

07. FLORO

Lampadario Ø42 H.140 cm. Struttura in acciaio in finitura Champagne lucido. Diffusore in vetro opalino satinato soffiato a mano con dispersione di foglia oro.

Chandelier Ø42 H.140 cm. Structure in steel with polished champagne-lacquered finish. Diffuser in hand-made blown glass with satin opaline finish and dispersion covered in gold leaf.

08. FLORO

Piantana Ø35 H.160 cm. Struttura in acciaio in finitura Champagne lucido. Diffusore in vetro opalino satinato soffiato a mano con dispersione di foglia oro.

Floor lamp Ø35 H.160 cm. Structure in steel with polished champagne-lacquered finish. Diffuser in hand-made blown glass with satin opaline finish and dispersion covered in gold-leaf.

09. FLORO

Lampada da tavolo 32x30 H.65 cm. Struttura in acciaio in finitura Champagne lucido. Diffusore in vetro opalino satinato soffiato a mano con dispersione di foglia oro.

Table lamp 32x30 H.65 cm. Structure in steel with polished champagne-lacquered finish. Diffuser in hand-made blown glass with satin opaline finish and dispersion covered in gold-leaf.

10. AKIRA

Abat-jour 33x11 H.51 cm. Paralume a ventaglio pelle Soft 1118 Canapa con ricamo Ultrasound. Portalampade in ottone tornito con diffusore in vetro satinato. Base in ottone in finitura Champagne lucido.

Abat-jour 33x11 H.51 cm. Lampshade with fan-shape in leather Soft 1118 Canapa with Ultrasound embroidery. Lamp-holder in turned brass with diffuser in satin glass. Base in brass with polished champagne-lacquered finish.

11. FIDELIO

Mirror 100x11 H.130 cm. Struttura posteriore in metallo decorato con stampa marmorizzata ad alta risoluzione. Specchio centrale sospeso con retro illuminazione a LED.

Mirror 100x11 h.130 cm. Back structure in metal decorated with a high-resolution marbled printing. Suspended central mirror equipped with back-lit LED light.

12. SOFFIO n 16. 17

Art work 75 x 35 x 4 cm. Pasta di vetro con foglia d'oro bianco e malta, ferro.

Art work 75 x 35 x 4 cm. Glass paste with white golden leaf, mineral oxide and mortar, iron frame.

13. SOFFIO n 20

Art work 60 x 50 x 4 cm. Vetro, ossido minerale e malta, ferro.

Art work 60 x 50 x 4 cm. Glass, mineral oxide and mortar, iron frame.

14. SOFFIO n 15

Art work 60 x 60 x 4 cm. Calcare, malta e stucco, ferro.

Art work 60 x 60 x 4 cm. Limestone, mortar and stucco, iron frame.

15. ALVEOLIZZAZIONE

Art work 50 x 60 x 4 cm. Malta, ferro.

Art work 50 x 60 x 4 cm. Mortar, iron.

16. PHILIDOR

Tappeto 250x350 cm. Tappeto in bamboo silk, taftato a mano in bamboosilk e lana New Zealand con lavorazione carving manuale. Backing in cotone.

Hand-tufted carpet in bamboo silk and New Zealand wool with hand-carving decoration. Backing in cotton.

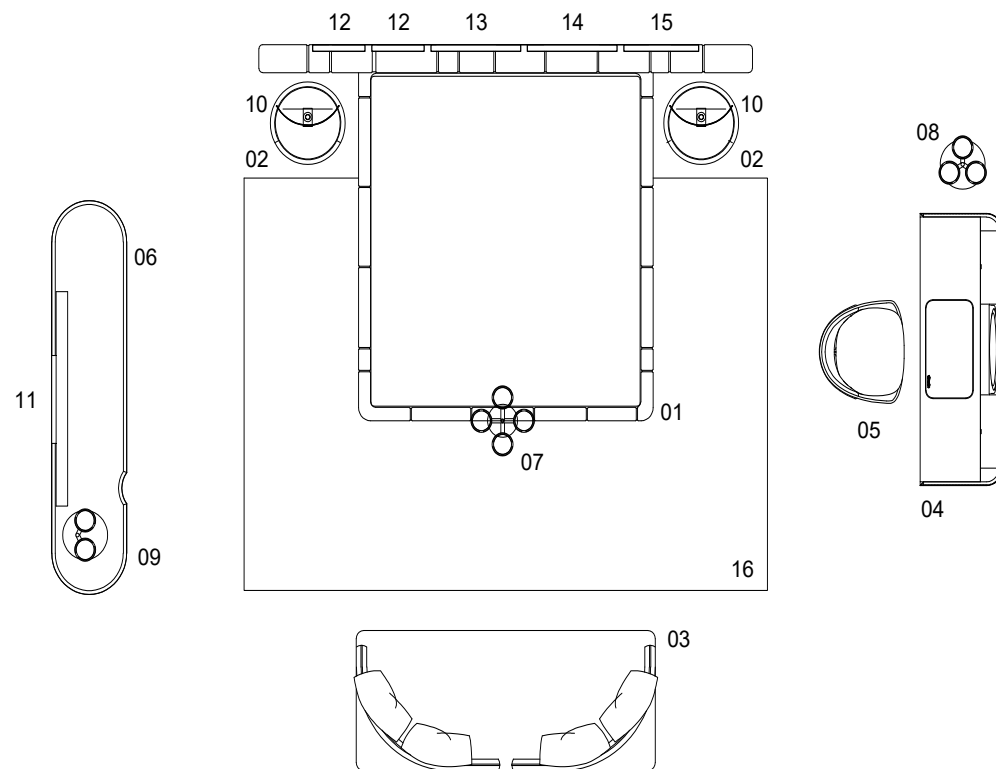

Produced by
©IPE SRL
ALL RIGHTS RESERVED

Visionnaire Logo, catalogue and advertising images are sole propriety of IPE srl, henceforth any use of the logo or adaptation of images is strictly forbidden without IPE srl prior approval; nonetheless, in any case the images must be used in such a way that there is no reasonable doubt that those belong to IPE srl and refer to IPE srl products.

No part of this publication can be reproduced or transmitted in any form or by any means, both electronic or mechanical, including photocopying and recording, or via any information storage and retrieval system, without written permission of the publisher.

Art Director: Eleonore Cavalli



Tutti i colori dei rivestimenti, pelli e tessuti, delle lacche, dei vetri, dei marmi e dei tappeti non possono essere considerati come riferimento colore. Le misure dei prodotti possono subire delle modifiche rispetto alle indicazioni del catalogo.

All colors of leather or fabric's covers, lacquered wood, mirrors, marbles and carpets can't be considered as color references. The dimensions of products are subject to change according to the instructions of the catalog.

I.P.E. S.r.l.
Via Mattei 1 — 40069 Zola Predosa (Bo) Italy
tel. +39 051 6186311 — fax +39 051 6186310
www.ipe-cavalli.it
www.visionnaire-home.it
ipe@ipe.it



